

miniWIPER for C7 Logger User's Manual

Copyright 2016
All Rights Reserved

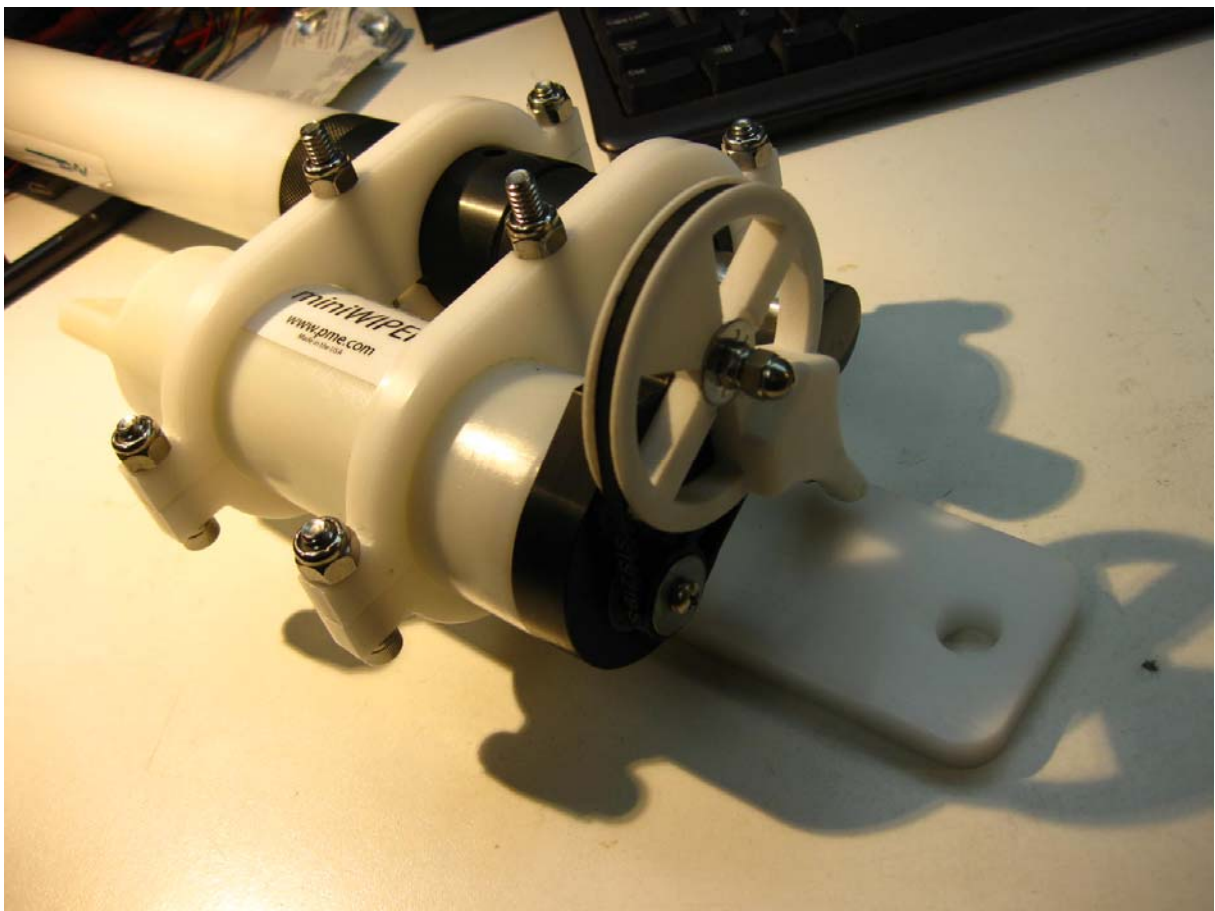

Warranty

1-YEAR LIMITED WARRANTY ON miniWIPER HARDWARE

Precision Measurement Engineering, Inc. (PME) warrant that the miniWIPER shall be free of defects in workmanship and materials, under normal 1 wipe per hour use, for a period of one year from the date of shipment. This warranty is made only to the original purchaser. In the event a miniWIPER covered by this warranty fails to operate according to our published specifications, then return it freight pre-paid to PME or an authorized Service Provider. PME will repair the unit at no charge to the customer and bear the cost of return shipment. Carefully pack all components, as the customer is responsible for any freight damage.

This warranty does not apply to services or consumable / expendable items (such as batteries, fuses and ropes) required for general maintenance. Equipment manufactured by other companies (such as meteorology sensors, solar panels, etc) are warranted only to the limit of the warranties provided by their original manufacturer.

PME makes no warranty, either expressed or implied, that the wiper will be operable after it is exposed to unusual adverse environmental conditions, oil fouling, freezing, extreme low temperatures or others.

This warranty is void if, in our opinion, the miniWIPER has been damaged by accident, mishandled, altered, or repaired by the customer, where such treatment has affected its performance or reliability. In the event of such treatment by the customer, costs for repairs plus two-way freight costs (no COD shipments will be accepted) will be borne by the customer. In such cases, an estimate will be submitted for approval before repair work is started. Items found to be defective should be returned to PME carefully packed, as the customer will be responsible for freight damage.

Incidental or consequential damages or costs incurred as a result of the product malfunction are not the responsibility of PME.

For all warranty or non-warranty returns please obtain, complete, and submit a RMA to PME. This RMA form may be obtained at

<http://www.pme.com/HTML%20Docs/RMAform.html>.

After submission of this form, then PME will respond with a RMA number. Please place this number on all shipments and related communications.

CONTENTS

Chapter 1 Installation

- 1.1 Overview
- 1.2 Installation Instructions
- 1.3 Wipe Considerations

Chapter 2 Software

- 2.1 Overview and Software Installation
- 2.2 miniWIPERControl
- 2.3 miniWIPERPlot
- 2.4 miniWIPERConcatenate

Chapter 3 miniWIPER

- 3.1 Overview
- 3.2 Opening and Closing the Wiper
- 3.3 Electrical Connections and Controls
- 3.4 Battery Replacement

Chapter 1: Installation

1.1 Overview

Your miniWIPER will provide a gentle brush action across the Cyclops 7 optical surface, which is intended to reduce or eliminate fouling organisms. This wiper is an accessory for the Cyclops 7 that can be added at any time.

The wiper will wipe at intervals between 1 hour and 24 hours. At time of shipment the wiper is set to wipe every 6 hours. Wipe interval can be selected by the customer with intervals as short as 1 hour or as long as 24 hours. (Wipe intervals outside this range are available. Please contact PME.)

miniWIPER connects to a Windows host computer via USB and appears as a Local Disk. This local disk contains software to select wipe intervals and perform other tasks. miniWIPER records various parameters each time it performs a wipe. These appear as files on this local disk.

The miniWIPER for Cyclops 7 product consists of the wiper motor, USB communication cable, and bracket shown in the picture below. The Cyclops 7 shown is supplied by the customer.

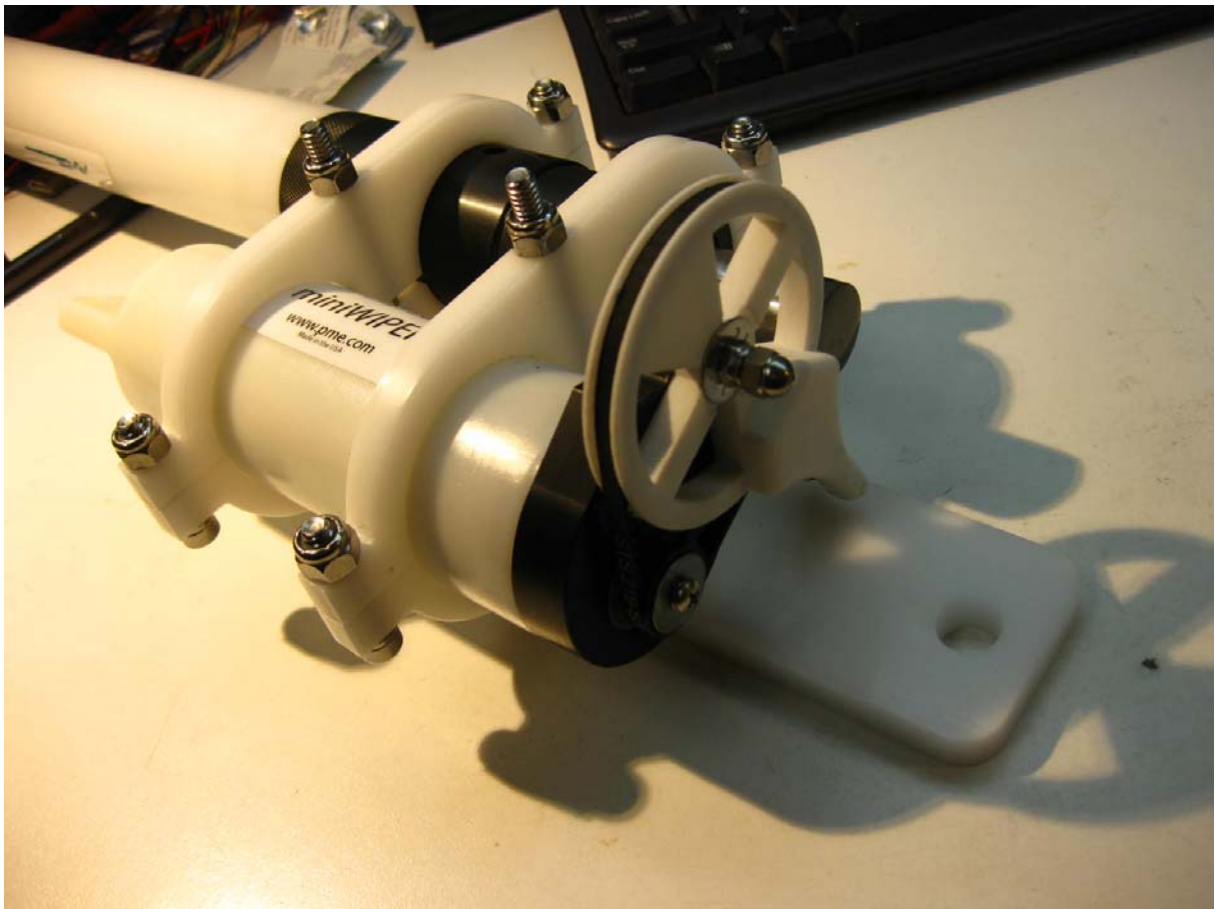

1.2 Installation Instructions

Begin miniWIPER operation by setting the Wiper Control Switch to "WIPE" as described in Chapter 3 of this manual. Begin Cyclops 7 Logger operation as described in the Cyclops 7 Logger Manual. Operation of both units must begin now since their control switches will not be accessible after they are mounted in the bracket.

Construct the bracket from the parts supplied by PME as shown in the picture below. Install bolts and nuts loosely. Please note that the wiper and Cyclops 7 have different diameters and so will only fit on one side or the other of the bracket.

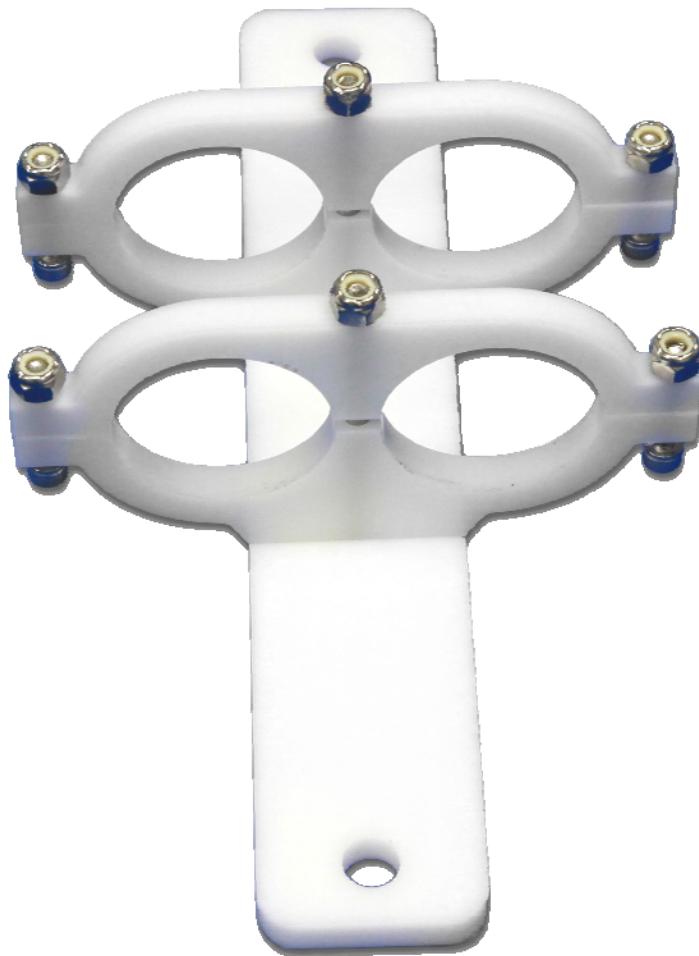

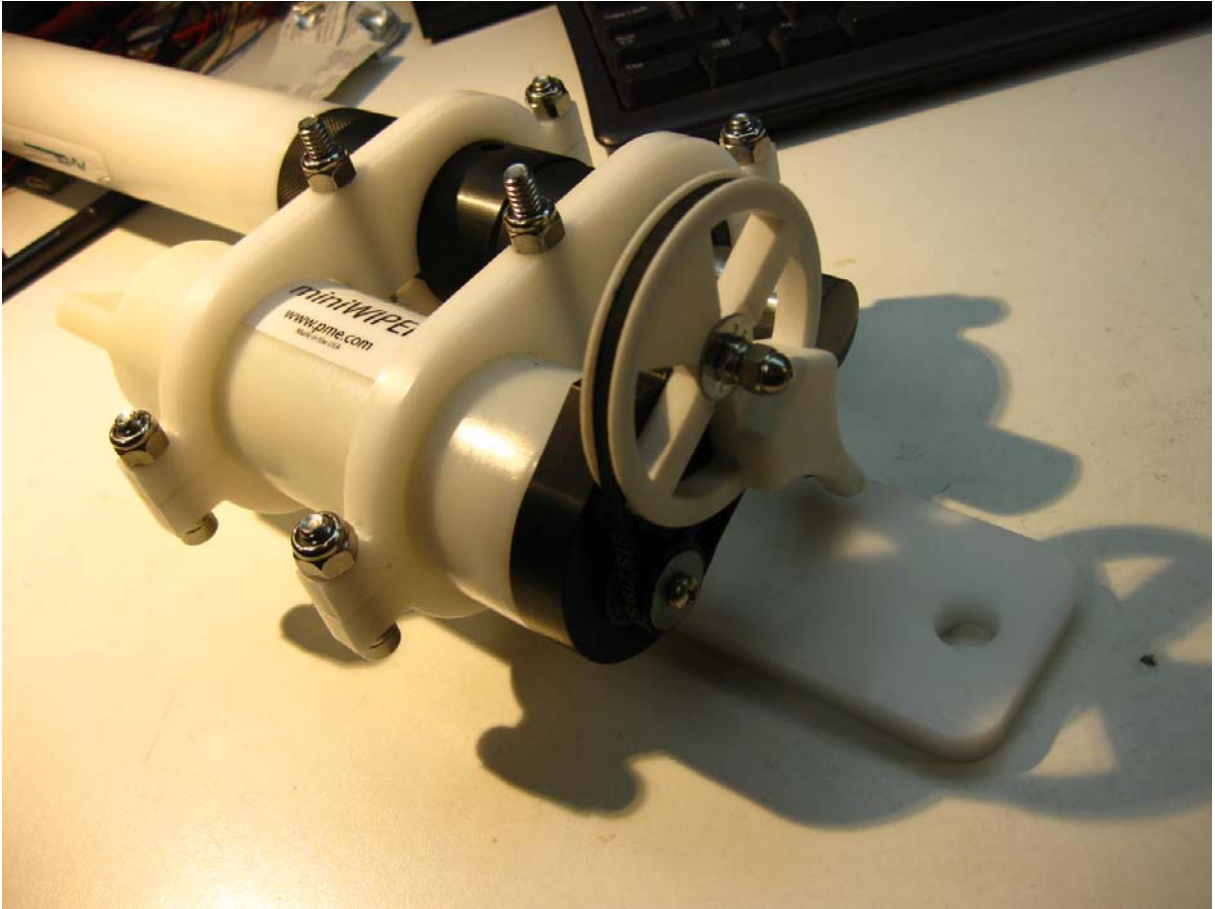

Rotate miniWIPER and Cyclops 7 Logger until the Cyclops 7 Logger optical surface and the wiper pulley axes are as shown in the pictures. The picture below shows the required alignment.

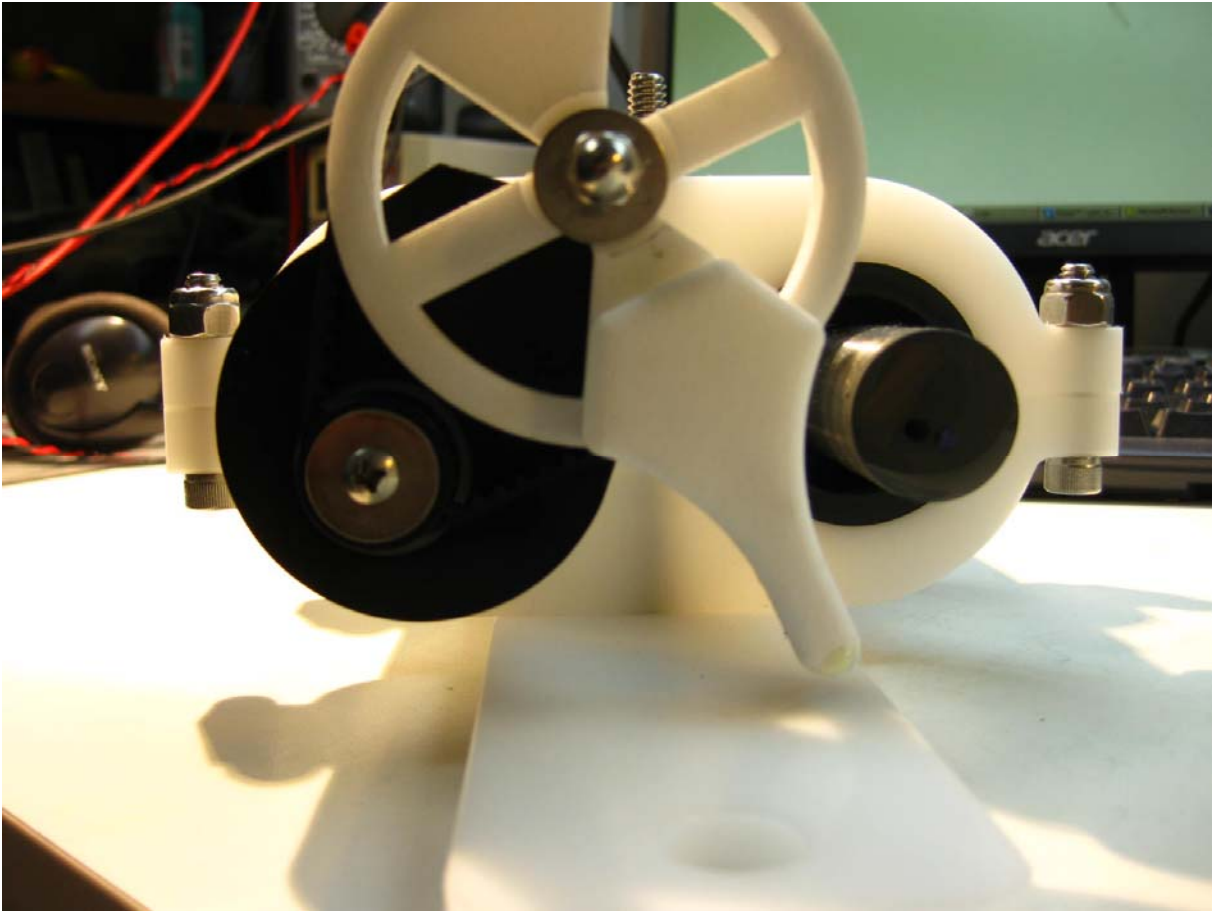

While maintaining the alignment (pictured above), slide miniWIPER and Cyclops 7 Logger relative to each other until the brush engages the optical surface as shown below. You may rotate the small pulley slowly by hand. This causes the internal motor to turn but will not damage miniWIPER. **DO NOT ROTATE THE LARGE PULLEY BUT INSTEAD ALLOW THE BELT TO MOVE THIS PULLEY WHILE ROTATING THE SMALL PULLEY BY HAND. ROTATION OF THE LARGE PULLEY BY HAND CAN DAMAGE miniWIPER.** We also suggest aligning the miniWIPER by using the included magnet. By waving the magnet over the miniWIPER, it will automatically begin a wipe.



Tighten the 6 bolts while maintaining the miniWIPER and Cyclops 7 positions. First tighten the 4 outer bolts until the gap in white plastic closes. Next tighten the inner two until the miniWIPER and Cyclops 7 Logger are securely held. A small gap in white plastic on these inner bolts will remain when all is secure.

Trigger a wipe by passing a strong magnet near the miniWIPER. Observe the wipe. The wiper will move the brush past the optical surface, then back up to the initial position. Hopefully this action will be detrimental to whatever fouling organisms are attempting to colonize the foil.

Please note that miniWIPER will not respond to the magnet if miniWIPER is not in Wipe mode.

1.3 Wipe Considerations

Brush Force - The amount of force placed by the brush onto the optical surface depends on how closely the brush is positioned against the foil. There is a trade-off here which is selected by adjusting the brush against the optical surface. Scrubbing organisms from the surface is hard on the organisms (which is a good thing) but also hard on the surface itself. The surface should resist more than a year of hourly gentle scrubbing. Brush pressure and also wipe interval must ultimately be selected to respond to local fouling conditions.

You may have to adjust the brush position from time to time as the brush wears. The brush will likely require replacement from time to time.

Wiping and Recording Interval – At each wipe miniWIPER makes various measurements of internal features and records these. The default wipe interval is 6 hours. However, it is also possible to instruct the miniWIPER to wipe and record at different intervals. This is accomplished by running the miniWIPERControl.jar program supplied with the miniWIPER. Recording intervals must be 1 or more hours and must be less than or equal to 24 hours. Intervals outside this range will be rejected by the miniWIPERControl program. (Contact PME for other recording intervals.)

Please refer to Chapter 2 for instructions on operating the miniWIPERControl program.

Time – All miniWIPER times are UTC (formerly known as Greenwich mean time (GMT)). The miniWIPER internal clock will drift in the <10 ppm range (< about 30 seconds/month) so you should plan to connect it occasionally to a HOST computer having an Internet connection. The miniWIPERControl program will automatically set time based on an Internet time server.

Please refer to Chapter 2 for instructions on operating the miniWIPERControl program.

File Information – The miniWIPER software creates 1 file daily on the miniWIPER's internal SD card. The number of wipes recorded in each file will depend upon the wipe interval. Files are named by the time of the first measurement within the file based on the miniWIPER's internal clock and expressed in YYYY-MM-DD HHMMSSZ.txt format. For example a file having the first measurement on September 9, 2014 at 17:39:00 UTC will be named

2014-09-09 173900Z.txt.

Files can be uploaded from the miniWIPER by connecting it to a HOST computer. Use the HOST computer's copy/paste functions to move the files from the miniWIPER to the HOST computer.

Each wipe recording within the files has a time stamp. The time stamp format is Unix Epoch 1970, the number of seconds that have passed since the first moment of 1970. This may be inconvenient in some cases. If so, use the miniWIPERConcatenate program which not only concatenates all the files, but also adds more readable statements of the time stamp.

Please refer to Chapter 2 for instructions on operating the miniWIPERConcatenate program.

The miniWIPER requires time and battery energy to work through the file directory on the SD card to allocate new file space. A few hundred files on the SD card is not a

problem, but as the number of files grows large into the thousands then the miniWIPER may suffer decreased battery life or other performance problems. Please, at the earliest convenient time, copy the recorded files to a HOST computer and delete them from miniWIPER's SD card. Also, do not use miniWIPER to store files unrelated to the miniWIPER's operation.

AA Alkaline Battery Life – Alkaline batteries will give somewhat less performance than lithium, especially at low temperatures. Alkaline batteries are superior to lithium in one way: you can determine how much battery life remains by measuring the battery terminal voltage. For short deployments alkaline batteries will provide adequate performance. For longer deployments, or for deployments in cold environments substitute lithium batteries.

AA Lithium Battery Life – The miniWIPER consumes battery energy mostly from operating the wiper motor, but also slightly from simply keeping track of time, writing files, sleeping, and other activities. The amount of energy consumed at each wipe depends on the friction in the mechanical system, on the hydrostatic loading of the wiper shaft, and especially on the environmental temperature. Unfortunately deep deployments also tend to be cold, which is the worst case.

At the time of this writing it appears that about 10K wipes can be obtained in shallow warm water. At 25 meter depths we estimate about 8K wipes in warm water. Cold temperature change battery performance substantially. A safety factor of 2 should definitely be applied. At present we recommend deployments be for no longer than 3 months or 2K wipes.

miniWIPER records battery voltage and also the number of wipes. It is not possible to accurately tell the charge state of a lithium battery by measuring its terminal voltage since this voltage responds to battery temperature. If you have a general idea of the number of wipes already obtained on a battery, then you can make a guess as to how many more wipes remain.

Monitor battery terminal voltage. You cannot tell from terminal voltage of a lithium battery how long the battery will last, but you can tell if it will die soon. The Low Drain Performance plot below gives an estimate of terminal voltage for both lithium and alkaline batteries. Your measured voltage will be 2X what is shown below since there are two batteries in series within the miniWIPER. You can operate batteries down to about 2.8 Volts (for two in series, 1.4 Volts on the graph below). Measure the series voltage as shown in the picture below. Your batteries are dead if this measurement is less than 2.8 Volts at room temperature, higher if at low temperature.

You may also use alkaline AA batteries such as Duracell Coppertop. They will not last nearly as long, especially at low temperatures, but will likely be adequate for several weeks at 1 hour interval.

When replacing batteries use only fresh batteries. Don't mix battery types. If one battery differs in type or charge level from the other and the miniWIPER runs them to full discharge, then one battery may leak.

Err on the side of caution when planning your deployment.

The recommended battery is the Energizer L91 lithium battery. For more information including the performance at low temperatures, use this link:

<http://data.energizer.com/PDFs/l91.pdf>

The figure below gives a general idea of terminal voltage vs. lifetime. Service life in hours is incorrect since miniWIPER draws 50 to 100 mA depending on various factors, but the general shape of the voltage vs. time gives an estimate of life remaining. This plot is taken from the manufacturer's specification. The plot is for a single battery. Double the voltages shown to give the terminal voltage as measured in the picture above. The miniWIPER halts operation at a total of 2.8 Volts.

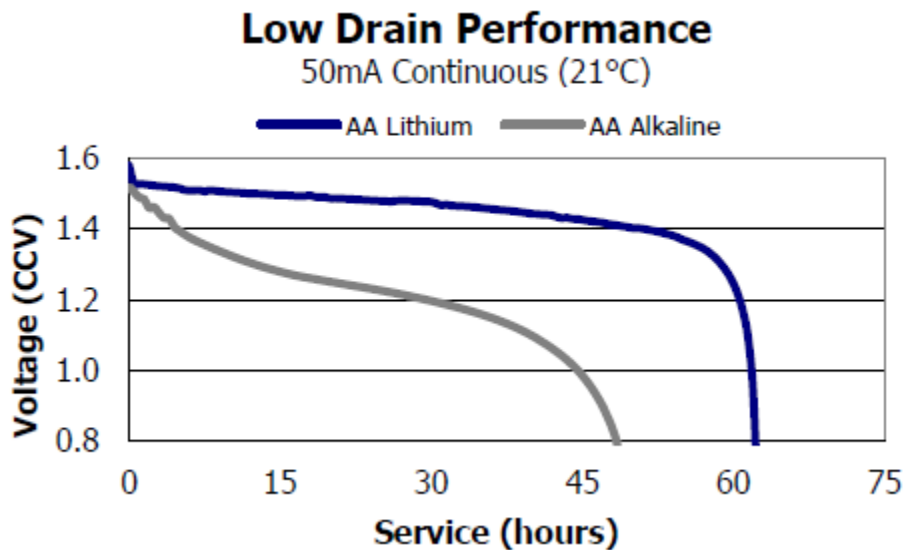

Battery Life Examples – The several figures below show battery life tests for the very first wiper made. Tests were conducted of a wiper installed on a miniDOT and so do not completely represent the C7 wiper, but should be similar. Tests were at 3 wipes per minute with 12 hour calibration (a miniDOT wipe feature) wipe interval. All tests conducted at atmospheric pressure. Different wipers will have different endurance due to differences in temperature, hydrostatic pressure, and the individual wiper's mechanical friction. Please use a safety factor of 2 for shallow water and 4 for deep water when planning battery life.

When evaluating the status of batteries from terminal voltage please remember the voltages presented below vary with temperature and also vary depending on how frequently the wiper is actuated. The tests below are somewhat artificial since the wiper wipes very frequently in the tests compared to expected field use.

Energizer L91 Lithium AA at room temperature. 12211 single scrub wipes.

miniWiper Measurements

5958-200186

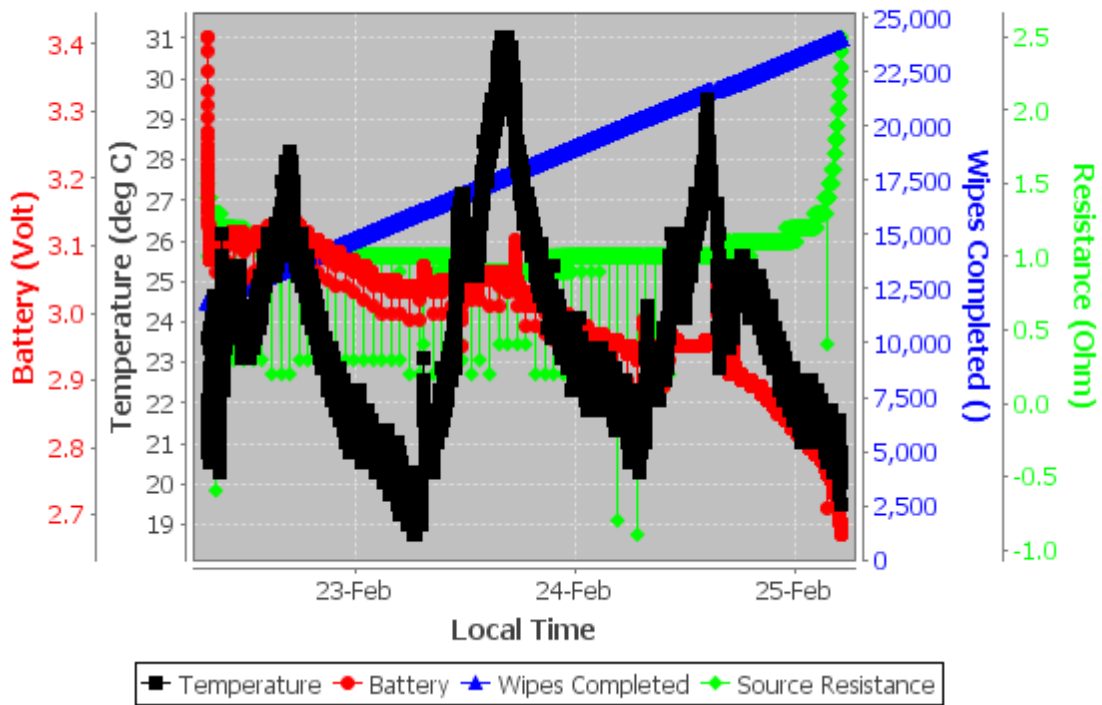

Duracell alkaline AA at room temperature. 7533 single scrub wipes.

miniWiper Measurements

5958-200186

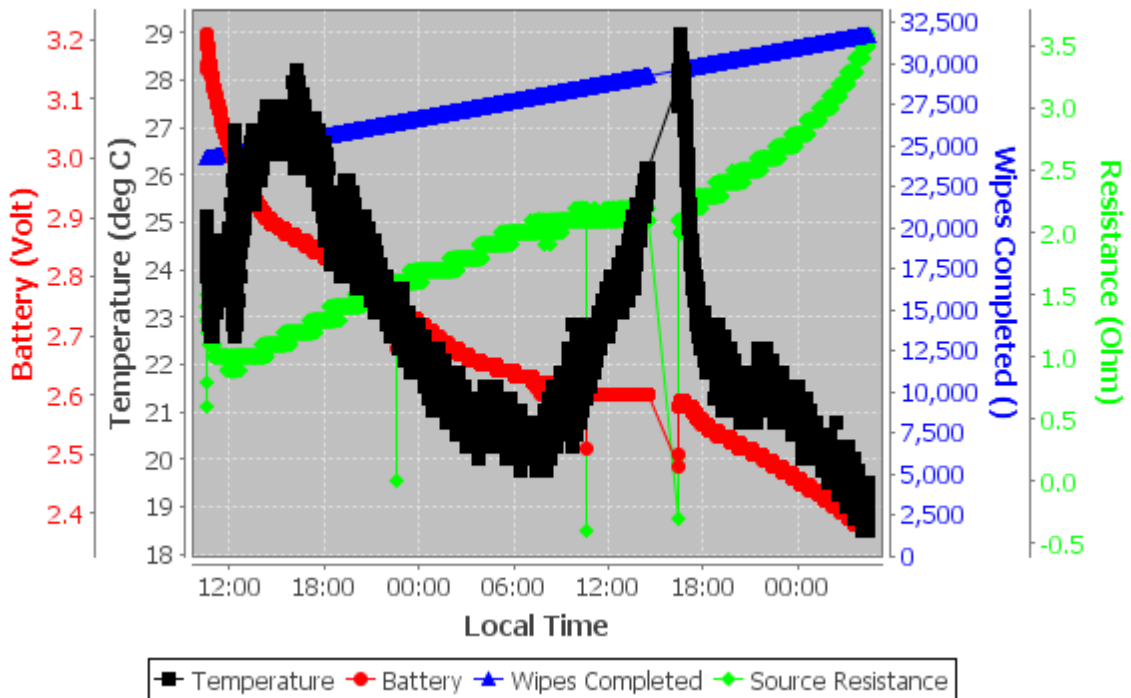

Energizer L91 Lithium AA at 4 deg C. 12785 single scrub wipes, no pressure.

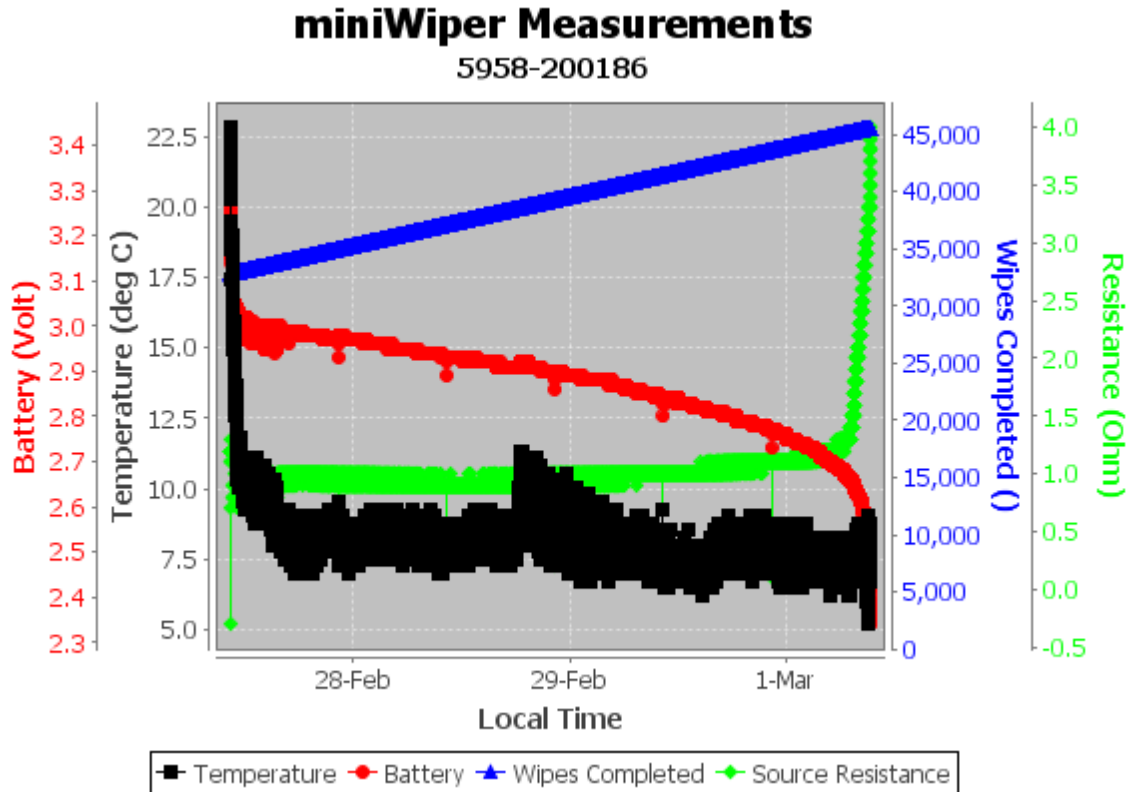

Coin Cell Battery Life – The miniWIPER uses a coin cell battery for backup of the clock when the power is switched off. This coin cell battery will supply many years of clock operation. Should the coin cell battery discharge, then it must be replaced by PME. Contact PME.

Maintenance – The miniWIPER will require maintenance from time to time. Parts most likely to need replacement are the brush and the o-ring sealing the drive shaft. The brush will be replaced by the customer by replacing the brush+wheel. The o-ring can be replaced by the customer. We do not know the replacement interval at this time.

Housing O-Ring and Seal – When the white pressure housing is screwed on to the black end cap, then it passes along the o-ring located in the black end cap several revolutions. Keep this o-ring lightly lubricated with silicone grease or an oil compatible with buna-N o-ring material.

When the miniWIPER is opened after deployment a small number of water drops are deposited on the inner surface of the o-ring. When the white pressure housing is screwed back on to the black end cap, then these drops can become trapped inside the miniWIPER. Be sure to carefully dry the o-ring and adjacent surfaces (especially underneath) prior to closing the miniWIPER. Re-lubricate the o-ring at this time.

LED Indications – The miniWIPER indicates its operation with its LED. The table below presents LED indications:

LED	Reason
1 Green Flash	Normal. Presented immediately after new batteries are installed. Indicates that the CPU has started its program.
5 Green Flashes	Normal. Indicates that miniWIPER is beginning to record measurements. This indication appears in response to switching the Logger Control Switch to “Record.”
5 Red Flashes	Normal. Indicates the miniWIPER is ending recording of measurements. This indication appears in response to switching the Logger Control Switch to “Halt.”
Continuously Green	Normal. Indicates the miniWIPER is connected to a HOST computer via the USB connection.
Continuously Flashing Red	SD card write error or dead batteries. Try removing/reinstalling batteries. Contact PME.

Closing and Opening – Close and open the miniWIPER like you would a flashlight; open by unscrewing the white pressure housing from the black end cap. Close by screwing the white pressuring housing on to the black end cap. When closing, do not tighten the white pressure housing. Just screw it on until it makes contact with the black end cap. See Chapter 3 for more instructions.

Storage When Not in Use – Remove the batteries. Keep the black end covered with the cap supplied by PME. If the cap is lost, then cover the black end cap with aluminum foil. There may be a calibration effect of ambient lighting so attempt to keep ambient light from reaching the sensing foil as much as possible.

Java – miniWIPER programs depend on Java and require Java 1.7 or higher. Update Java at

<https://java.com/en/download/index.jsp>

Upload Files to an Android device –

It is possible to transfer your measurement files from the miniWIPER to your Android device. This operation has 3 prerequisites.

1. An Android device equipped with USB On-The-Go (OTG) feature. OTG is a feature for most modern Android devices that allow them to act as a USB host. OTG was introduced with Android version 3.1 and should be a useable feature for **most** devices. It is still possible that your device doesn't support OTG. Please test your device with a miniWIPER **prior** to attempting to upload while in the field.
2. A USB OTG cable. This is essentially an adapter with a micro USB connector on one end that connects to your Android device and a standard A type USB plug on the other. The cable supplied with the miniWIPER connects to this end.

3. A "File Explorer" app should be downloaded on your Android device. These types of apps assist with being able to view and move files from device to device. "ES File Explorer" is a free app available on the Google app store and is recommended for use with the miniWIPER.

If the 3 requirements are met, then connect the miniWIPER to your Android device. You should see the miniWIPER's green connection light come on and your Android device will display a message about "preparing USB storage". When "USB storage ready" is shown, then use your "file explorer" program to move your data from the miniWIPER onto your Android device.

Again, it is highly recommended that you try this operation at your workstation prior to depending upon this in the field.

Currently the associated miniWIPER programs miniWIPERPlot and miniWIPERConcatenate are not supported by the Android devices. Please contact PME for further information.

Chapter 2: Software

2.1 Overview and Software Installation

Software is supplied on CD or in a zip file. Copy or unzip to any folder on your computer's hard drive. The software will contain these files:

- **miniWIPERControl.jar** allows you to see the state of the wiper as well as set the wipe interval.
- **miniWIPERPlot.jar** allows you to see plots of recorded wipe parameters.
- **miniWIPERConcatenate.jar** gathers all daily files into one CAT.txt file.
- **Manual.pdf** is this manual.

These files are located on the root directory of the miniWIPER. This appears as a Local Disk when miniWIPER is connected to a Windows host computer.

PME suggests you leave these programs where they are on the miniWIPER, but you may copy them to any folder on your host computer's hard drive and operate them from this location.

miniWIPERControl, miniWIPERPlot, and miniWIPERConcatenate are Java language programs that require the host computer to have the Java Runtime Engine V1.7 (JRE) or later installed. This engine is commonly required for internet applications and will likely already be installed on the host computer. The JRE can be downloaded via internet from

http://www.java.com/en/download/windows_xpi.jsp

At this time miniWIPER is supported on Windows operating systems, but may also operate on Macintosh and perhaps Linux.

2.2 miniWIPERControl

Begin program operation by clicking on miniWIPERControl.jar. Software presents the following screen (shown after miniWIPER is connected):

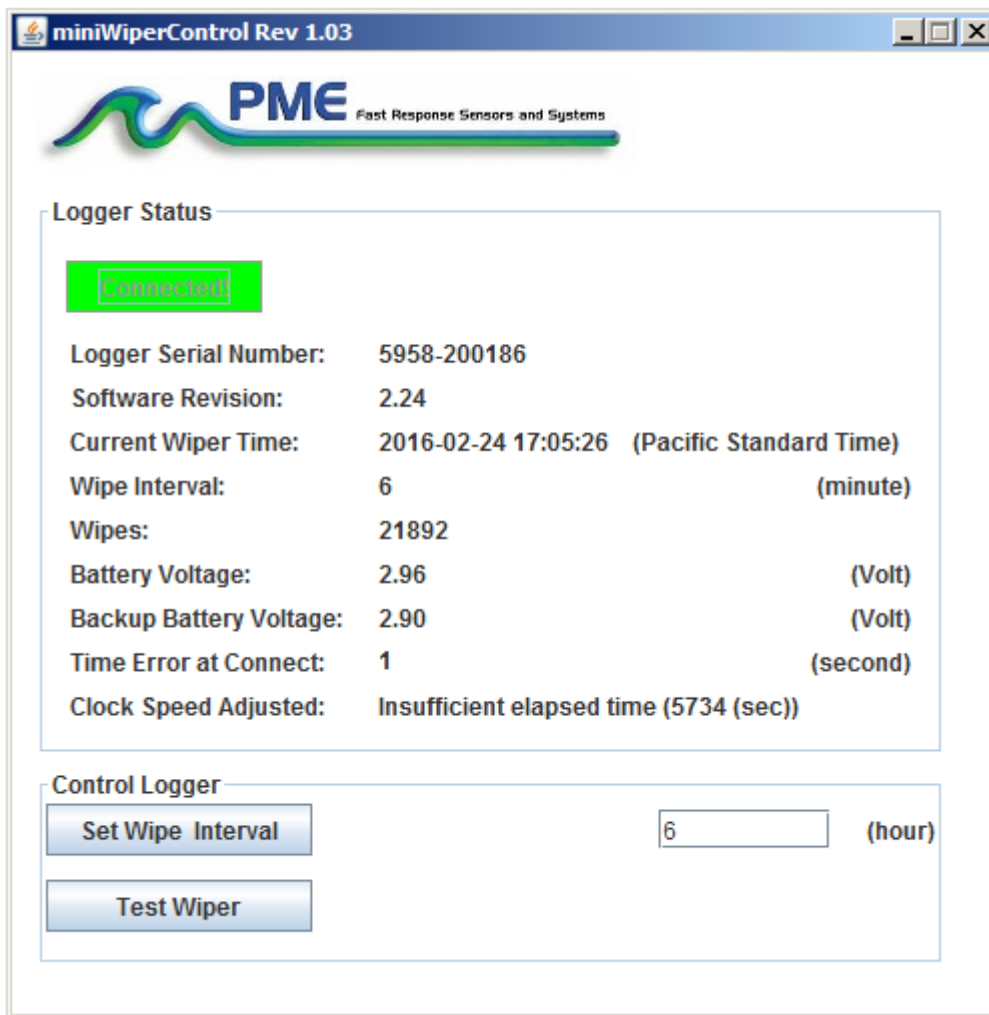

The miniWIPER must be connected to USB at this time. When correctly connected the miniWIPER LED will display a constant green light.

Click the Connect Button. The software will contact the wiper. If the connection is successful the button will turn green and display “Connected” as shown above. The Serial Number and other parameters will be filled in from information taken from the miniWIPER.

If the host computer is connected to the internet, the current difference between an internet time server’s time and the miniWIPER internal clock will be displayed. And, if more than a week has passed since time was last set, the miniWIPER clock will be set and a check mark icon will appear. If the host computer is not connected to the internet no time services will occur.

The current miniWIPER wipe interval will be displayed next to the Set Wipe Interval button. If this interval is acceptable the interval need not be set.

To set the interval, enter an interval not less than 1 hour and not greater than 24 hours. Click the Set Sample Interval button. Shorter and longer intervals are available. Contact PME.

Click the test wiper button to operate the wiper motor briefly. The wiper will make one complete wipe over a period of about 30 seconds. (A complete wipe is rotation in one direction only. Note that miniWIPER occasionally does a calibration wipe in addition to a scrub wipe. A calibration wipe is a wipe to both rotational endpoints without scrubbing.)

End miniWIPER Control by closing the window. Unplug miniWIPER USB connection.

Upon disconnection of the USB cable the miniWIPER will begin wiping or remain halted as indicated by the position of the Wiper Control Switch.

2.3 miniWIPERPlot

Begin the program operation by clicking “miniWIPERPlot.jar”. The program presents the screen shown below.

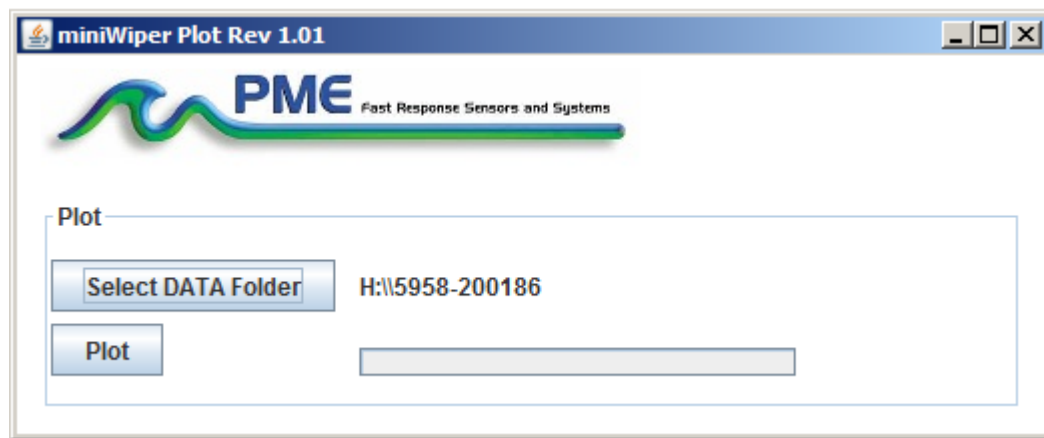

The miniWIPERPlot program plots the files recorded by the miniWIPER. The program reads all the miniWIPER files in a folder, except the CAT.txt file.

Select the folder that contains the files recorded by the miniWIPER. If the miniWIPERPlot program is run directly from the miniWIPER, then the program will suggest the folder that is located on the miniWIPER's SD card. You may accept this by clicking “Plot”, or you may click “Select DATA Folder” to browse to your HOST computer's hard drive. If the number of measurements recorded is small, for example a few thousand, then these can conveniently be plotted directly from the miniWIPER's storage. However, it is best to copy large measurement sets to the HOST computer and select them there. The file access to the miniWIPER is slow.

The miniWIPER's measurement folders must NOT contain any files besides those the miniWIPER recorded and the CAT.txt file.

Click “Plot” to begin plotting.

The program reads all the miniWIPER's data files in the selected folder. It concatenates these and presents plots that are similar to the plots shown below

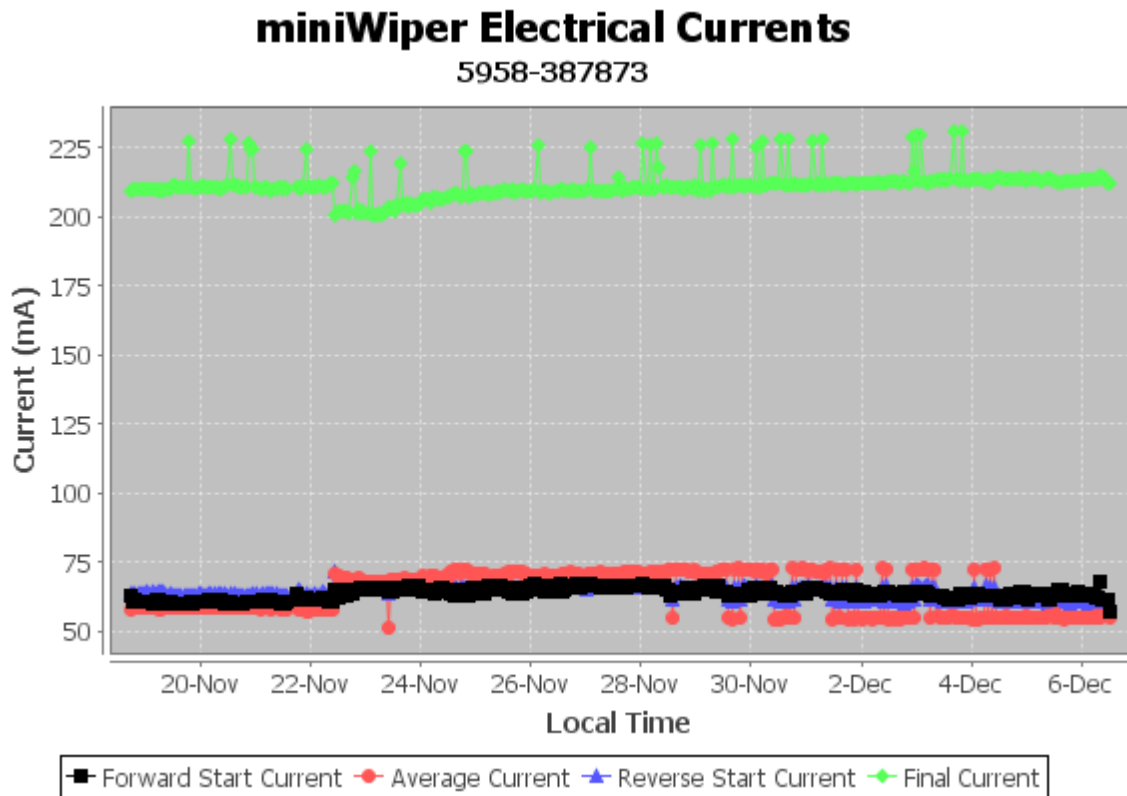
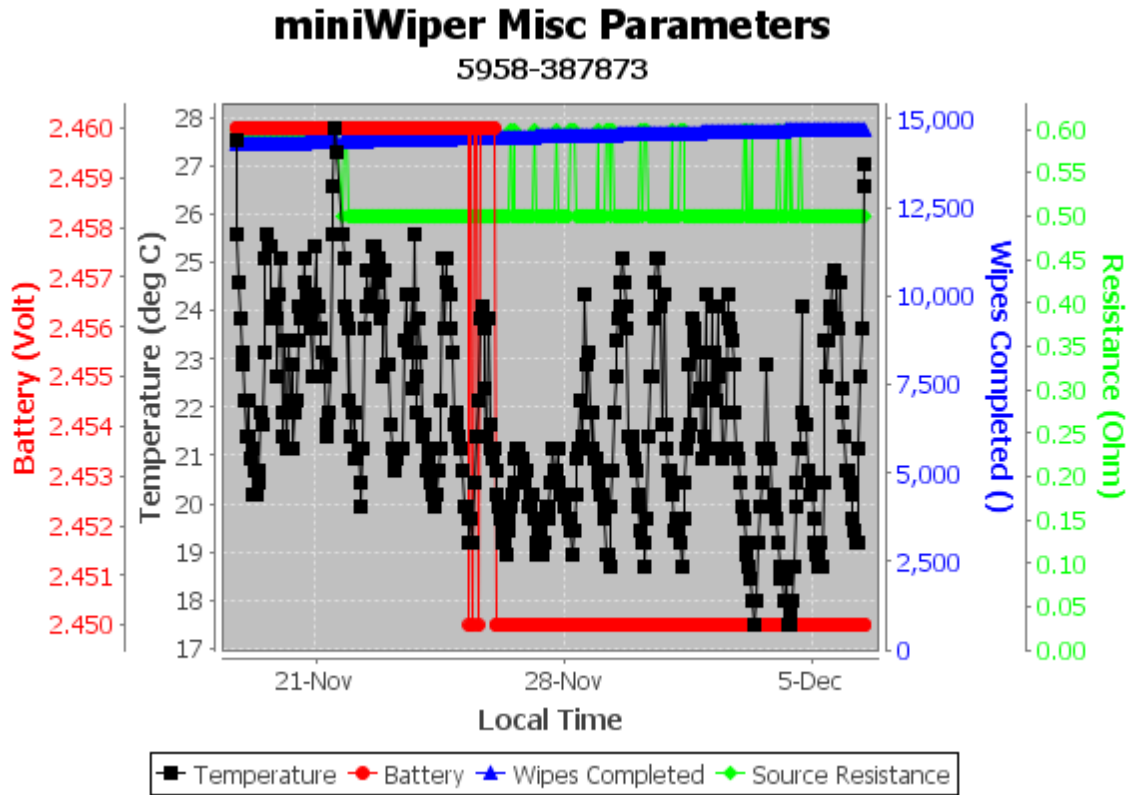

miniWiper Operation Times

5958-387873

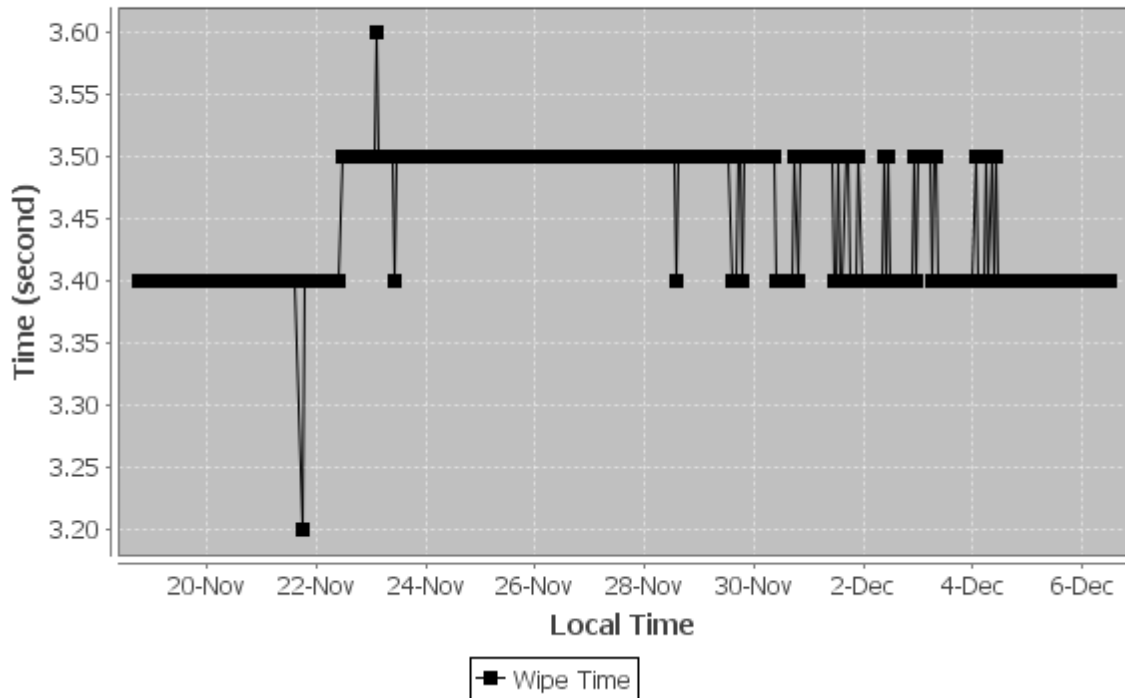

miniWiper Measurements

5958-387873

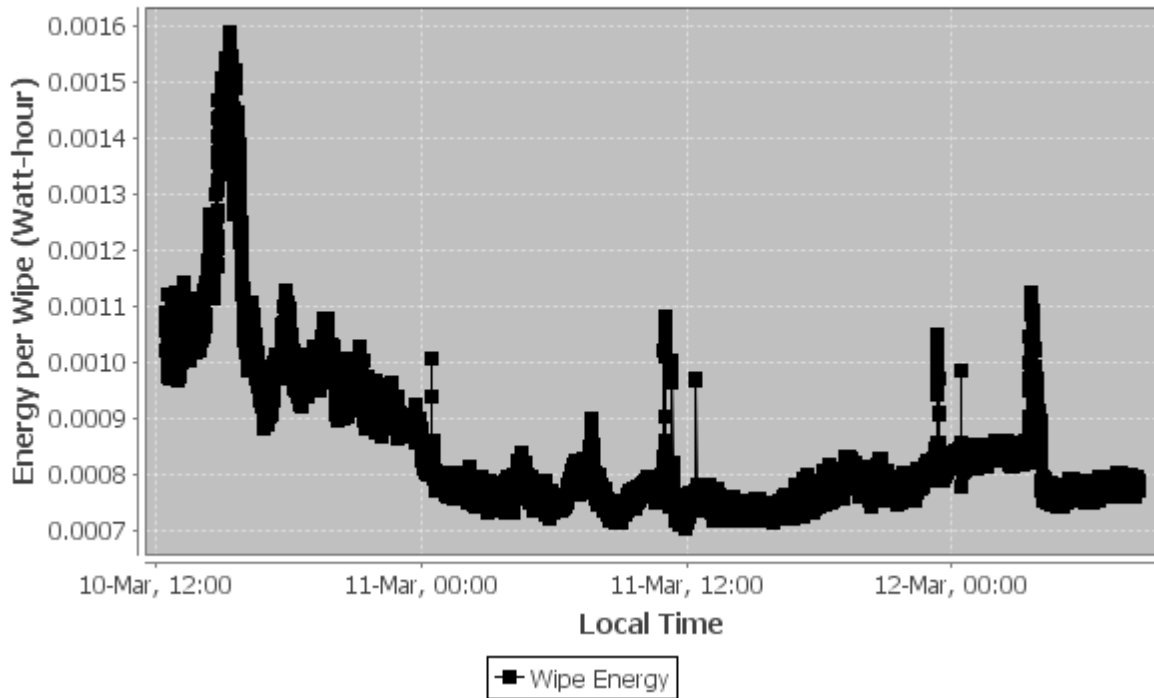

You may zoom this plot by drawing a square from upper left to lower right (click and hold left mouse button) that defines the zoom region. To zoom completely out, attempt to draw a square from lower right to upper left. Right click on the plot for

options such as copy and print. The plot can be scrolled with the mouse while the Control key is held depressed. Copies of the plot can be obtained by right clicking on the plot and selecting Copy from the pop-up menu.

Different DATA Folders can be selected during one session of the program. In this case the software produces multiple plots. Unfortunately, the plots are presented exactly on top of one other and so when a new plot appears it is not obvious that the old plot is still there. It is. Just move the new plot to see previous plots.

The program can be re-run at any time. If an already processed DATA Folder is selected, then the program simply reads the miniWIPER's measurement files again.

End the miniWIPERPlot program by closing the window.

In general the recorded information will not be very useful to customers, save that it shows battery voltage and # of wipes. However it may prove very useful should a wiper fail. Here is a list of information as well as why it is useful.

Temperature - The temperature within miniWIPER at the time of the wipe. +/- 5 deg C

Battery - Battery voltage measured just prior to beginning a wipe. Note that calibration events immediately precede wipes and give an draw the voltage down from its pre-wipe value. Useful to see battery condition and useful for calculation of source resistance which rises dramatically at end of life.

Forward Start Current - The highest current observed during the first 1 second of motor operation as forward wipe begins. Useful to identify sticky mechanical systems.

Average Current - The average current after 1 second of operation. Useful to determine average mechanical system friction.

Reverse Start Current - the highest current observed after 1 second of motor operation as the back wipe begins. Useful to identify peak mechanical system friction.

Final Current - the current at the end of the wipe. Wipe end is identified as either time out or high motor current.

Wipe Time - the time to make a complete forward/reverse wipe.

Wipes Completed - the total number of wipes the miniWIPER motor has made. Reset to 0 if motor is replaced. Useful for determining wear on motor and also for providing a stamp value for other service events. Like miles on the odometer!

Source Resistance - the average decline in battery terminal voltage from no load value to operating value, divided by average motor current. Useful in determining health of battery.

Energy per Wipe - Please review the Low Drain Performance figure in section 1.3. The lithium batteries can provide 0.050 Amp service for roughly 50 hours at 1.4 Volts. miniWiper uses two batteries so the miniWiper battery can supply about $2 * (0.05 * 1.4 * 50) = 7$ Watt-hours total energy. A rough estimate of number of wipes available can be obtained by dividing the total battery energy by the amount of energy consumed per wipe.

Please understand that this is just an estimate. Different wipers will have different amounts of mechanical friction that the batteries must overcome. Battery life will also vary dramatically as the mechanical friction of the individual wiper responds to hydrostatic pressure and will vary especially with battery temperature since the amount of energy a battery can provide declines at lower temperatures.

Once the performance of a wiper is established in a known deployment, the Energy per Wipe plot can be used to make an informed guess of battery life.

2.4 miniWIPERConcatenate

Begin the program operation by clicking “miniWIPERConcatenate.jar”. The program presents the screen shown below.

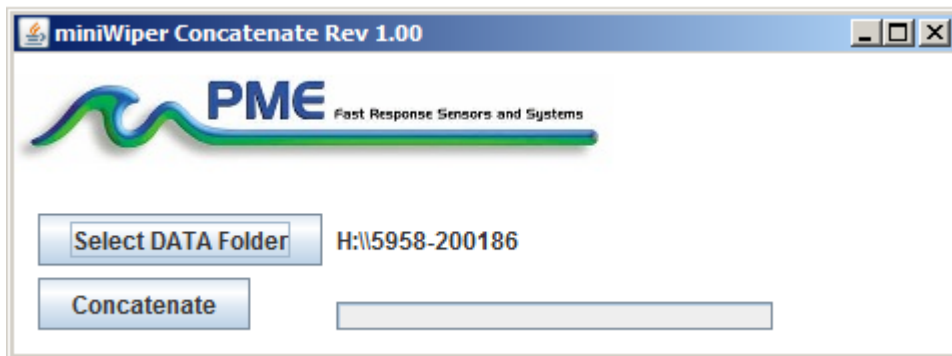

The miniWIPERConcatenate program reads and concatenates the files recorded by the miniWIPER. This program produces a CAT.txt file in the same folder as selected for the data. The CAT.txt file contains all the original measurements and contains two additional statements of time.

Select the folder that contains the files recorded by the miniWIPER. If the miniWIPERPlot program is run directly from the miniWIPER, then the program will suggest the folder located on the miniWIPER. You may accept this by clicking “Concatenate”, or you may click “Select DATA Folder” to browse your HOST computer’s hard drive. If the number of measurements recorded is small, for example a few thousand, then these can conveniently be plotted directly from the miniWIPER Logger’s storage. However it is best to copy large measurement sets to the HOST computer and select them there. The file access to the miniWIPER is slow.

The miniWIPER measurement folders must NOT contain any files besides those the miniWIPER recorded and the CAT.txt file.

Click “Concatenate” to begin concatenating files and create the CAT.txt file.

The CAT.txt file will resemble the following:

```
miniWiper Concatenated Data File
-----
Logger: 5958-200186
Concatenation Date: 2016Feb22 07:33:12 PST
Scrub: 1 ( ) Angle: 45 (deg)
Timeout: 8 (second) Threshold: 175 (mA)

    Unix Timestamp,          UTC_Date_& Time,          Pacific Standard Time,      Battery,  Temperature,
    (Second),                (none),                    (none),                    (Volt),  (deg C),
1455130200,                2016-02-10 18:50:00,      2016-02-10 10:50:00,      3.130000, 0.009000,
1455130230,                2016-02-10 18:50:30,      2016-02-10 10:50:30,      3.120000, 0.007000,
1455130260,                2016-02-10 18:51:00,      2016-02-10 10:51:00,      3.120000, 0.009000,
1455130290,                2016-02-10 18:51:30,      2016-02-10 10:51:30,      3.120000, 0.007000,
1455130320,                2016-02-10 18:52:00,      2016-02-10 10:52:00,      3.120000, 0.008000,
1455130350,                2016-02-10 18:52:30,      2016-02-10 10:52:30,      3.120000, 0.009000,
1455130380,                2016-02-10 18:53:00,      2016-02-10 10:53:00,      3.110000, 0.008000,
1455130410,                2016-02-10 18:53:30,      2016-02-10 10:53:30,      3.110000, 0.007000,
1455130440,                2016-02-10 18:54:00,      2016-02-10 10:54:00,      3.110000, 0.009000,
1455130470,                2016-02-10 18:54:30,      2016-02-10 10:54:30,      3.110000, 0.006000,
1455130500,                2016-02-10 18:55:00,      2016-02-10 10:55:00,      3.110000, 0.009000,
1455130530,                2016-02-10 18:55:30,      2016-02-10 10:55:30,      3.110000, 0.007000,
1455130560,                2016-02-10 18:56:00,      2016-02-10 10:56:00,      3.110000, 0.008000,
1455130590,                2016-02-10 18:56:30,      2016-02-10 10:56:30,      3.110000, 0.009000,
```

End the miniWIPERConcatenate program by closing the window.

Chapter 3: miniWIPER

3.1 Overview

The miniWIPER is intended to provide a gentle wiping of the miniWIPER oxygen-sensitive membrane at user-programmable intervals. Customers will be required to open the wiper to set the wiper interval or to exchange the batteries. This chapter describes the wiper internal features.

3.2 Opening and Closing the Wiper

The wiper circuitry is contained in a waterproof housing that must be opened. The housing is opened by unscrewing the white pressure housing from the black end cap. Turn the pressure housing counter clockwise relative to black end cap. Close by reversing this procedure after being sure that the o-ring is free from debris. Lube o-ring occasionally with grease intended for buna-N o-ring material.

Please attempt to handle the miniWIPER only by the aluminum chassis, without touching the circuit card.

When closing the miniWIPER just screw the white cylinder onto the black end cap until the cylinder just touches the end cap. Do not tighten! miniWIPER tends to get a little tighter during deployment.



3.3 Electrical Connections and Controls

Removal of the cover reveals the wiper connections and controls, shown below.



The **LED Light** is a red or green LED. This is used to indicate different features described elsewhere in this manual.

The **Wiper Control Switch** controls the wiper mode:

- **Wipe** – When the switch is in this position wipes occur.
- **Halt** – When the switch is in this position wipes do not occur.

The **USB Connection** allows communication between the wiper and an external computer. When connected, the wiper is in halt mode regardless of the Wiper

Control Switch setting. When disconnected the wiper mode is controlled by the Wiper Control Switch. The switch position may be changed while the USB is connected.

The **Main Batteries** (2 X AA on side opposite to pictured above) provide main power to the miniWIPER. Note the positive (+) terminal.

3.4 Battery Replacement

Be sure that the replacement battery is compatible with miniWIPER. PME recommends Energizer L91 AA size batteries. You may also use AA size alkaline batteries such as Duracell Coppertop.

<http://data.energizer.com/PDFs/l91.pdf>

http://ww2.duracell.com/media/en-US/pdf/gtcl/Product_Data_Sheet/NA_DATASHEETS/MN1500_US_CT.pdf

Caution: Improper replacement of the battery will damage the miniWIPER. Installing the batteries backwards will permanently damage the miniWIPER.

Follow these steps:

- 1) Move the Wiper Control Switch to the *HALT* position.
- 2) Remove the depleted batteries **noting the position of the (+) terminal**.
- 3) Use only new, fully charged batteries of the same type.
- 4) Install fresh batteries with the **(+) position the same as the removed battery**. The (+) position is also marked on the inside of the battery holder.
- 5) The miniWIPER LED Light should flash once to indicate that software is beginning operation within a second or two after you complete the battery installation. At this time the wiper will enter the mode selected by the Wiper Control Switch.

Record the number of wipes at battery replacement time. This may be helpful later when determining battery depletion.