Advanced Portable Model AQ4000

INSTRUCTION MANUAL



AQUAfast, Auto-ID, Cahn, EZFlash, Ionalyzer, ionplus, KNIpHE, ORION, perpHect, PerpHecT, PerpHecTion, pHISA, pHix, pHuture, Pure Water, Sage, Sensing the Future, SensorLink, Sure-Flow, TEA Analyzer, Titrator PLUS, TURBO2 and Wine Master are registered trademarks of Thermo Orion.

1-888-pHAX-ION, A⁺, All in One, Aplus, AQUAsnap, AssuredAccuracy, AUTO-BAR, AUTO-CAL, AUTO DISPENSER, AUTO-LOG, AUTO-READ, AUTO-STIR, Auto-Test, BOD AutoEZ, Cable-Free, CERTI-CAL, CISA, DataCOLLECT, DataPLUS, digital LogR, DirectCal, DuraProbe, Environmental Product Authority, Extra Easy/Extra Value, FAST QC, GAP, GLPcal, GLPcheck, GLPdoc, ISEasy, KAP, LabConnect, LogR, Low Maintenance Triode, Minimum Stir Requirement, MSR, NISS, No Cal, One-Touch, One-Touch Calibration, One-Touch Measurement, Optimum Results, Pentrode, pHuture MMS, pHuture Pentrode, pHuture Quatrode, pHuture Triode, Quatrode, QuiKcheK, rf link, ROSS, ROSS Resolution, SAOB, Smart CheK, Stacked, Stat Face, The Enhanced Lab, ThermaSense, Triode, TRIUMpH, Unbreakable pH, Universal Access are trademarks of Thermo Orion.

Guaranteed Success and The Technical Edge are service marks of Thermo Orion.

PerpHecT meters are protected by U.S. patent 4,321,544.

ROSS and PerpHecT ROSS are protected by U.S. patent 4,495,050.

ORION Series A meters and 900A printer are protected by U.S. patents 5,108,578, 5,198,093, D334,208 and D346,753.

ORION 81, 82, 91, and 92 series glass electrodes are protected by U.S. patents 4,661,236 and 4,687,500.

Sure-Flow electrodes are protected by European Patent 278,979 and Canadian Patent 1,286,720.

ionplus electrodes and Optimum Results solutions have patents pending.

ROSS Ultra electrodes have patents pending.

© Copyright 2002, Thermo Orion. All rights reserved.

The specifications, descriptions, drawings, ordering information and part numbers within this document are subject to change without notice.

This publication supersedes all previous publications on this subject.

Table of Contents

Chapter I

Introduction	1
Display	2
Keypad	3

Chapter II

Instrument Set-up	4
Battery Installation	4
Cuvette Cover	5
Cuvette Adapter	6
RS232 Connection	7

Chapter III

Setup Menu	8
Setup Functions	8
Blank	9
Verify	10
Digits	12
Clock	12
Set Baud	13
Print	13
Auto Print	14
Self Test	14
Methods Update	15

Chapter IV

User Programs	16
Customer User Programs	16
Enter a User Program	16
Calibrate User Program	17

Chapter V

Measurement	19
Zero Procedure for the AQ4000	19
Sample Measurement with an Auto-Test™ Sample Cuvette	21
Sample Measurement Using Standard non Auto-Test Reagent Cuvettes	22

Chapter VI	
Log Function	23
Chapter VII	
Use with Printers and Computers	24
Data Transmission Settings	24
Chapter VIII	
Troubleshooting	25
Colorimeter Self-test	25
Maintenance	25
Operator Assistance Codes	26
Chapter IX	
Warranty	27
Chapter X	
Notice of Compliance	30
Chapter XI	
Specifications	31
Appendix A	
Ordering Information	33
Appendix B	
List of Program Numbers	36
Appendix C	
Method Sheets	39

Chapter I

Introduction

The Thermo Orion AQUAfast® IV Colorimeter Model AQ4000 is the most advanced portable microprocessor-based, LED colorimeter on the market today. It can be used for most common colorimetric measurements.* The colorimeter features the Thermo Orion exclusive Auto-ID™ test recognition capability that automatically recognizes the test and initiates measurement. Coupled with Thermo Orion's Auto-Test™, colorimetric testing has never been easier. Auto-Test cuvettes are premeasured, self-filling tests designed for many of the common water quality measurements.

The AQUAfast IV features preprogrammed methods as well as a custom calibration procedure. A simple user interface steps the user through set up and custom methods. The instrument will log 100 data points and download them to a printer or computer. The AQ4000 will never become obsolete because new methods can be easily downloaded to the unit.

* Now available for use on the AQ4000 are powder chemistry packs. The powder chemistry packs allow for easier and cleaner measurements. A large majority of AQUAfast II tablet chemistries can be used on the AQUAfast IV as well. The AQ4000 is also capable of measuring for COD.

Display

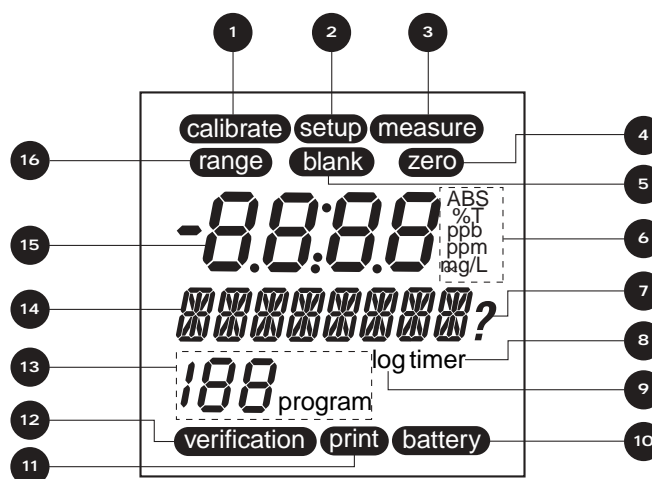

Figure 1 — Model AQ4000 Display

Item Number	Description	
1	Calibrate	Icon lit while AQ4000 is in calibration mode
2	Setup	Icon lit while AQ4000 is in setup mode
3	Measure	Icon lit during measurement
4	Zero	Icon lit while AQ4000 performs zero
5	Blank	Icon lit when a blank is active for selected method
6	Units	Icons for units of measurement
7	?	Icon lit when AQ4000 prompts a question
8	Timer	Icon lit while timer is active
9	Log	Icon lit if data is in AQ4000 log
10	Battery	Icon lit when battery in AQ4000 is low
11	Print	Icon lit during print function
12	Verification	Icon lit while AQ4000 is in method verification mode
13	188 program	Icon for active program number
14	αααα	Alphanumeric display
15	8888	Numeric display
16	Range	Icon lit to indicate over range condition

Keypad

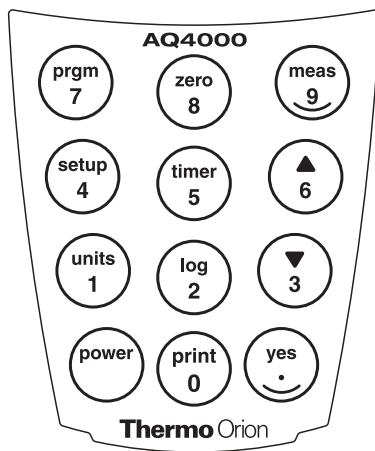

Figure 2 — Keypad

Key	Description
	Turns the AQ4000 on or off
	Initiates print mode or inputs number 0
	Confirms an answer or input of decimal point
	Allows selection of measurement units, mg/L, ppm, % T, absorbancy or inputs number 1
	Initiates data log mode or inputs number 2
	Scroll down or input number 3
	Initiates Setup mode or number 4
	Initiates Timer, allows access to Time/Date and Stopwatch or number 5
	Scroll up or input number 6
	Initiates program number input or number 7
	Initiates a zero measurement or number 8
	Initiates a measurement or number 9

Chapter II

Instrument Setup

Battery Installation

The model AQ4000 colorimeter requires 4 AA alkaline or lithium batteries. With 4 alkaline batteries, the expected life is 2,500 hours. With lithium batteries the expected life is 10,000 hours.

To install batteries, carefully loosen the two captive screws on the bottom of the battery cover. Remove the cover and insert batteries as shown in **Figure 3**.

Replace battery cover and tighten captive screws.

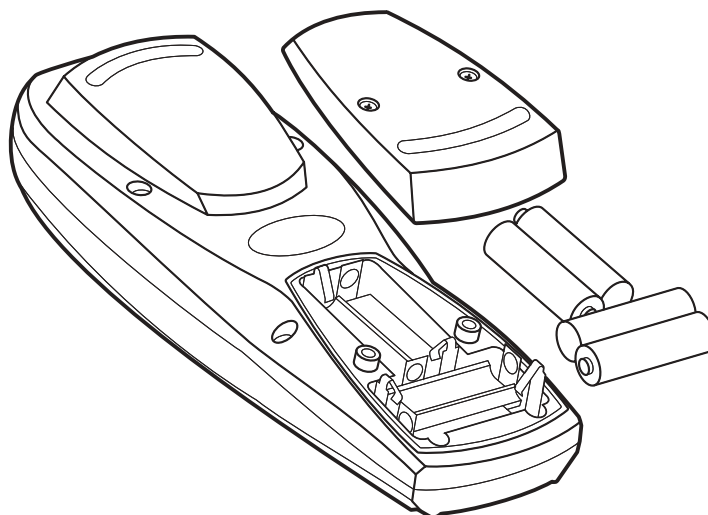

Figure 3 — Battery Installation

Cuvette Cover

The cuvette cover serves two functions; first, it keeps the optical well covered so dirt and dust do not enter the well. Second, it covers the cuvette during measurement to prevent stray light from affecting the measurement.

To remove cuvette cover, lift cover straight up as shown in **Figure 4**.

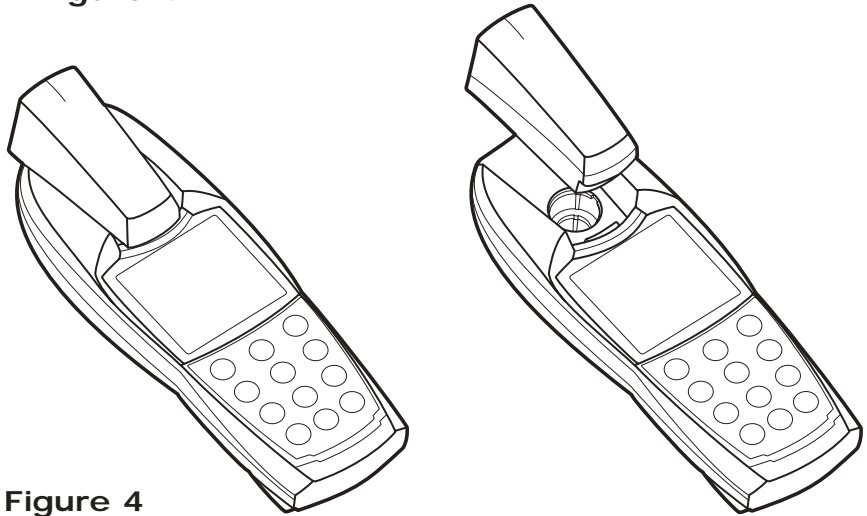

Figure 4

To cover a sample for measurement, carefully place cuvette cover over cuvette as shown in **Figure 5** aligning mark in cover with mark on colorimeter.

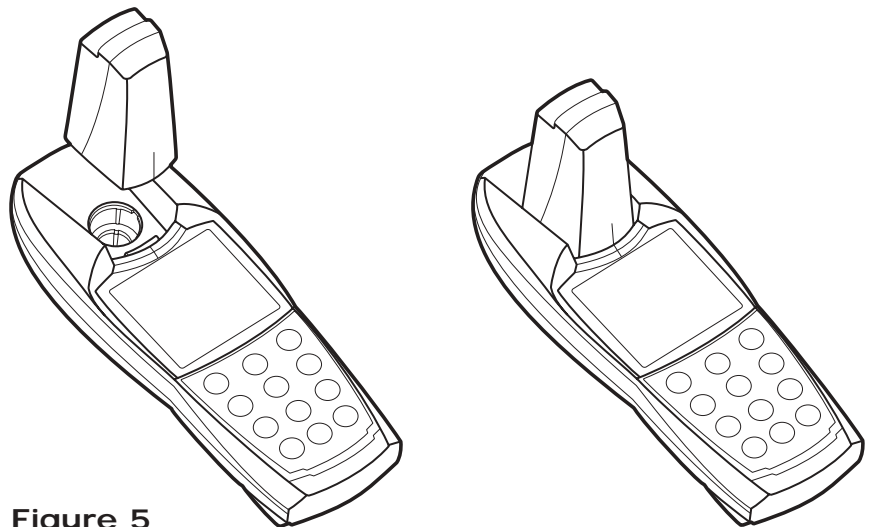

Figure 5

Cuvette Adapter

The AQ4000 is shipped with two cuvette adapters. One adapter is for 13 mm Auto-Test™ cuvettes and the other is for 16 mm cuvettes. If using 24 mm cuvettes, no adapter is required. The adapters ensure correct alignment of the cuvette in the well. If a cuvette is not aligned properly, i.e. not using the adapter, measurement errors may occur.

To insert adapter, align male tabs on adapter with slots in well. Push down adapter firmly until it snaps in place. See **Figure 6**.

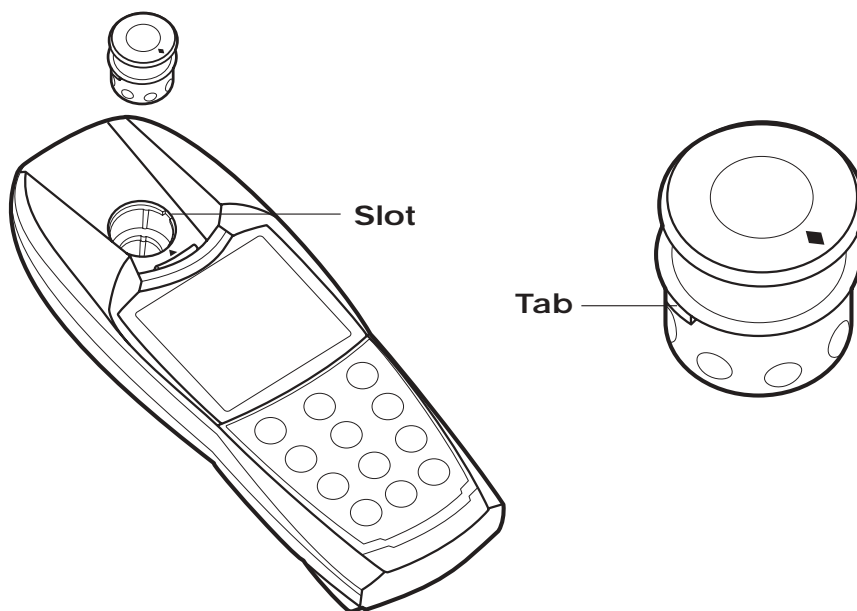

Figure 6 — Model AQ4000 with the Cuvette Adapter

RS232 Connection

The AQ4000 has a bi-directional RS232 port located on the underside of the colorimeter. See **Figure 7**. To connect the AQ4000 to a printer or computer, use RS232 cable AQ4CBL. Also see the **Use with Printers and Computers** section.

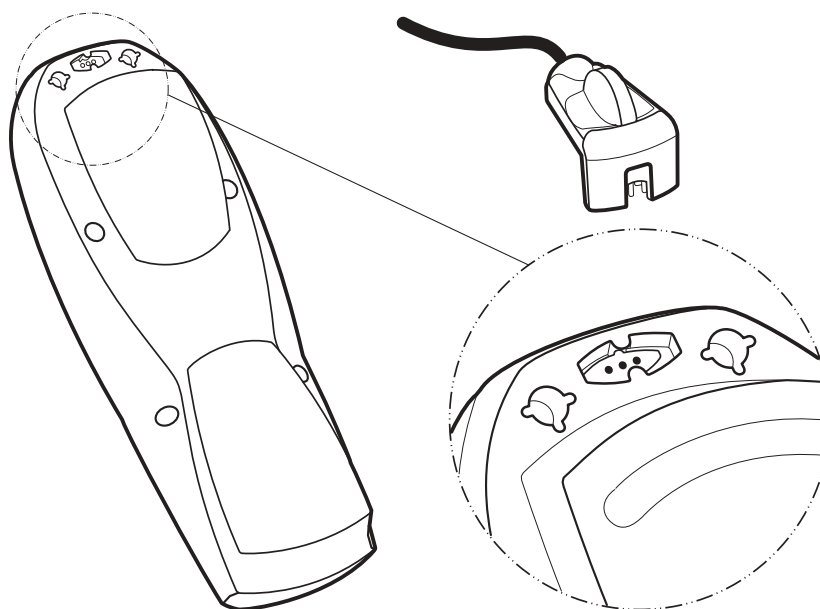

Figure 7 — Model AQ4000 Connection

Chapter III

Setup Menu

The Setup key allows the user to access all the user selectable functions in the AQ4000 colorimeter.

There are two levels of Setup menus available to the user. The first is a general setup menu used with any of the preprogrammed methods. The second is the setup menu used when selecting a custom or user program.

Setup Functions

General

Blank

Allows the user to set a reagent blank for a particular chemistry. The blank is method specific. Blank is not visible while in programs 1 through 4.

Verify

Allows the user to verify the quality of the measurement by either running a standard as a sample or doing a spike recovery. Verify is not visible while in programs 1 through 4.

Digits

Allows the user to select the number of significant digits to be displayed

Clock

Allows the user to set the date and time.

Set Baud

Allows the user to set the baud rate for the instrument when using it with a printer or computer.

Print

Allows the user to set the print out format.

Auto Print

Allows the user to set the colorimeter to automatically print each measurement.

Self-test

Allows the user to initiate a self-test to verify instrument operation.

Upload

Allows the user to upload current measurement technique into colorimeter.

User Program Only

User Prgm

Allows the user to enter a custom user program.

Cal User







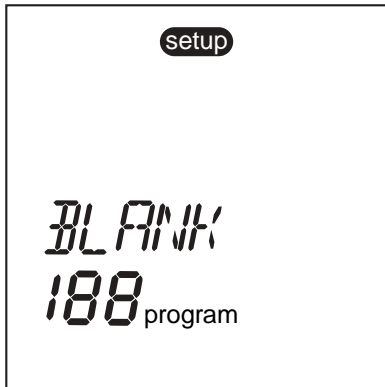

Allows the user to enter a calibration curve for the custom program which they entered.

Blank

The Blank function subtracts the color absorbed when running the test with deionized water as a sample. This allows the user to compensate for any background color due to the reagent. It should be noted this is done for a particular test and will only subtract the blank for that particular test.









To Set Blank



1. Press  key.
2. Press the  or  keys until "BLANK" is displayed.
3. Press  key, "SET BLNK?" will be displayed.
4. Press  key, "SAMPLE?" will be displayed.
5. Insert cuvette containing deionized water and reagent into sample well and cover.
6. Press  and allow instrument to read the blank.
7. Blank value will be displayed and unit will proceed to the next setup function.
8. To proceed to the measure mode, press  key to proceed to sample measurement or  key to proceed through the setup menu.

NOTE: Blank must be set for each desired test.

To Clear Blank

1. Press  key.
2. Press the  or  keys until "BLANK" is displayed.
3. Press  key, "SET BLNK?" will be displayed.
4. Press  or  keys, "CLR BLNK?" will be displayed.
5. Press  key to clear blank, "CLEARED" will be displayed.
6. To proceed to the measure mode, press  key to proceed to sample measurement or  key to proceed through the setup menu.





Verify

The keep function allows the user to check the quality of the measurement being made. Using the Direct Verification, a standard in the measurement range of the test can be read as a sample. This simple test procedure ensures a user is correctly measuring samples.

The Spike Recovery Verification is similar to a known addition. A standard of known concentration is added to an unknown sample. The spiked sample is then read and the AQ4000 calculates the concentration of the original sample. The AQ4000 steps a user through the measurement process and allows a simple verification of method validity.









Direct Verification



1. Press  key.
2. Press the  or  keys until "VERIFY" is displayed.
3. Press  key, "DIRECT?" is displayed.
4. Press  key, "SAMPLE?" is displayed.
5. If using an Auto-Test™ cuvette - Invert Auto-Test cuvette in standard solution to be measured and snap. If using a standard type cuvette, react standard solution with reagent as per instructions.
6. Wipe Auto-Test cuvette with soft cloth and insert into colorimeter.
7. Insert cuvette into AQ4000. Align the ▼ on the Auto-Test cuvette with the ◆ on the adapter to obtain a continuous beeping and view ***** across the display. If ***** and beeping is not observed, rotate cuvette right or left to initiate the measurement.
8. Cover cuvette. When wait time is complete, AQ4000 will proceed to measurement and value of standard will be displayed.

Spike Recovery









1. Press  key.
2. Press the  or  keys until "VERIFY" is displayed.
3. Press  key, "DIRECT?" is displayed.
4. Press  or  keys to display "SPK REC?"
5. Press  key, "STD CONC?" will be displayed.
6. Enter the concentration of the standard to be used for the spike. Press  key. It is recommended to use a standard 10 - 100 times more concentrated.
7. "SAMP VOL?" will be displayed. Enter to total volume of the sample.
8. "STD VOL?" will be displayed. Enter the volume of the spike to be added using numbers on keypad. It is recommended not to add more than 10% of the original sample volume.
9. In a beaker place sample and volumetrically add standard mix. If using an Auto-Test™ cuvette, transfer sample plus standard to the graduated sample cup.
10. "INS VIAL" will be displayed.
11. If using an Auto-Test cuvette - invert Auto-Test cuvette in sample plus standard solution to be measured and snap. If using a non Auto-Test type cuvette, react standard solution with reagent as described in instructions.
12. Wipe Auto-Test cuvette with soft cloth and insert into colorimeter.
13. Insert cuvette into AQ4000. Align the ▼ on the Auto-Test cuvette with the ◆ on the adapter to obtain a continuous beeping and view ***** across the display. If ***** and beeping is not observed, rotate cuvette right or left to initiate the measurement. If using a non Auto-Test type cuvette, insert cuvette into AQ4000 and press .
14. Cover cuvette. When wait time is complete, concentration of sample will be displayed.

Once verification has been completed, you can return to the measure mode by pressing  key.

Digits







The digit selection allows the user to select the resolution of the reading, from 0.000 \Rightarrow 0.00 \Rightarrow 0.0 \Rightarrow 0. (Default is 0.000)

1. Press  key.
2. Press the  or  keys until "DIGITS" is displayed.
3. Press  key to accept.
4. Press  or  keys until the desired resolution is selected.
5. Press  key to accept.

Clock







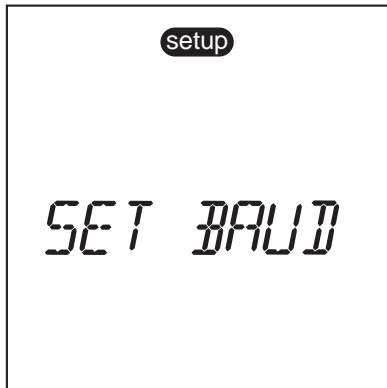

Allows the user to set the time and date.

1. Press  key.
2. Press the  or  keys until "CLOCK" is displayed.
3. Press  key to accept.
4. "20__" will be displayed. Enter the year.
5. "__Month" will be displayed. Enter the month.
6. "__Day" will be displayed. Enter the day.
7. "__:__ (24) hour" will be displayed. Enter the time.

Set Baud







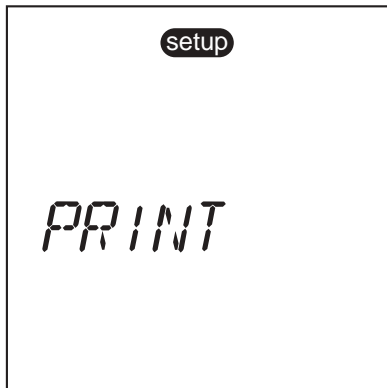

The default baud rate is 1200. The user may select another rate 1200 → 2400 → 4800 → 9600.

1. Press  key.
2. Press the  or  keys until "SET BAUD" is displayed.
3. Press  key to accept. 1200 or last baud rate selected is displayed.
4. Press  or  keys until the desired baud rate is selected.
5. Press  key to accept.

Print







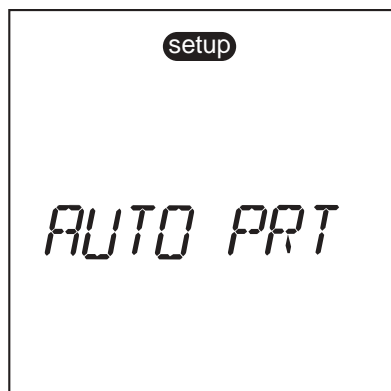

Allows the user to select the printout format. The user can select between a standard printout or a comma delimited format for importing data into a spreadsheet.

1. Press  key.
2. Press the  or  keys until "PRINT" is displayed.
3. Press  key to accept. "STND PRN?" is displayed.
4. Press the  or  keys to toggle between "STND PRN?" and "CMA DELM?".
5. Press  key to accept.

Auto Print



Auto print "ON" will automatically send readings to the printer.

1. Press  key.
2. Press the  or  keys until "AUTO PRT" is displayed.
3. Press  key to accept. "AUTO OFF?" or "AUTO ON?" is displayed.
4. Press the  or  keys to toggle between "AUTO OFF?" and "AUTO ON?".
5. Press  key to accept.

Self-test







Puts the colorimeter into a self-diagnostic mode.
See **Troubleshooting**.

Methods Update

The AQ4000 will never be obsolete. The colorimeter allows the user to update the method parameters whenever new parameters are released. The Update setup function is the process by which a user can add these new methods to their unit.

1) AQ4000



1. With power off, insert RS232 cable (Thermo Orion Cat. No. AQ4CBL) into AQ4000 RS232 port. A serial adapter may be required. See **Figure 7**, page 6.
2. Press  key.
3. Press  key.
4. Press the  or  keys until "UPLOAD" is displayed.
5. Press  key to accept.
6. Meter display should read "WAITING".

NOTE: To abort upload press  key again.

2) Computer

1. Install the RS232 cable into serial port of computer.
2. Install program disk into floppy drive or select file.
3. Double click on the file to open it.
4. Follow instructions provided on your computer screen.

Chapter IV

User Programs















Customer User Programs





To program the AQ4000 with a user program, enter a program number reserved for user programs. User Program numbers are program number 190 through 199.

1. To enter a user program, press  key.
2. Enter program number (190 – 199) for a user program.
3. AQ4000 will either display “No User X” or “** User X” if a program is stored in memory at that location. If a user program already exists, the user can choose to overwrite or select another program number.

Enter a User Program



1. Press  key.
2. Press the  or  keys until “USR PRGM” is displayed.
3. Press  key to accept.
4. “WAVELENGTH?” is displayed. Toggle between “REVIEW?” or “REPL OLD?” wavelength. Press  to accept. Press the  or  keys to select wavelength for analysis. 420 → 520 → 580 → 610 are the wavelength options available.
5. Press  key to accept wavelength selection.
6. “UNITS” is displayed. Press the  or  keys to select units displayed for the analysis. Units available are ppb → ABS → %T → g/L → mg/L → ug/L → ppm.
7. Press  key to accept unit selection.
8. “TIMER 1?” is displayed. Press  key to set the first Timer. Press the  or  keys to set the timer to the desired value.
9. Press  key to accept.

10. "TIMER 2?" is displayed. Press  key to set the first Timer. Press the  or  keys to set the timer to the desired value.
11. Press  key to accept.
12. "SAVE USR?" is displayed. Press  key to save program. " -SAVED—" will be displayed. AQ4000 will automatically proceed to "CAL USR".











NOTE: To escape without saving program press the  key at the "SAVE USR?" prompt.



NOTE: AQ4000 requires a calibration to be entered to use a custom program.

Calibrate User Program



To access "CAL USR" from the setup menu.

1. Press  key.
2. Press the  or  keys until "CAL USR?" is displayed.
3. Press  key to accept.
4. "3 CAL PTS?" will be displayed. Press the  or  keys to select the number of desired calibration points from 2 to 5.
5. Press  key to accept number of calibration points.
6. "PT1 CONC?" is displayed. Place cuvette with first standard in AQ4000. Ensure standard has been properly reacted and cover with cuvette cover.
7. Enter the value of the first standard using the numeric keypad. Press  key to accept value. If entering a number with a decimal, use the  key. If no decimal is required, press  key twice to accept value.

8. AQ4000 will read first standard and automatically proceed to second point.
9. "PT2 CONC?" is displayed. Place cuvette with second standard in AQ4000. Ensure standard has been properly reacted and cover with cuvette cover.
10. Enter the value of the second standard using the numeric keypad. If entering a number with a decimal, use the  key. Press  key to accept value. If no decimal is required, press the  key twice to accept value.
11. Repeat steps 9 and 10 for each of the remaining standards.
12. "CAL OK" will be displayed at the completion of the calibration.

Proceed to measurement section to measure samples using user program.

NOTES:

- A calibration must be performed with at least two points prior to AQ4000 allowing the user to measure with a user program.
- The instrument should be zeroed before calibration.
- It is recommended that the calibration should bracket the expected sample concentration.
- When using a custom program, calculation of unknown sample concentration is based on only two of the calibration points that were measured. Generally the points selected will bracket the sample concentration.

Chapter V

Measurement

Below are general instructions for using Auto-Test™ cuvettes, which work with the Auto-ID feature in the AQ4000. For specific test information, refer to instructions provided with test kits.

For best results, always cover cuvette with cuvette cover whenever zeroing or measuring a sample.

Zero Procedure for the AQ4000

The Zero function sets a zero reference for the measurement. The AQ4000 must be zeroed prior to each series of measurements. The zero is done using unreacted sample or distilled water in a zero cuvette. The AQ4000 is shipped with a Zero Cuvette kit, Thermo Orion Cat. No. AQ4ZER. Included in the kit are three zero cuvettes. One zero cuvette is filled with distilled water and sealed. This can be used if your unreacted sample is very clean and colorless. Two additional zero cuvettes with removable caps are provided. These cuvettes can be used for sample that has any color or turbidity to them. Both types of zero cuvettes have an Auto-ID code. Choose the cuvette most appropriate for your type of measurement.

When Zero is performed, it is a universal zero, all wavelengths are zeroed at the same time. For best results, perform a zero before each new type of test. If zeroing with a colored sample and the next sample is clear, repeat zero. If using a colored sample with one test only, one may choose to use the blank function.

NOTE: For best results, Zero before each new method.

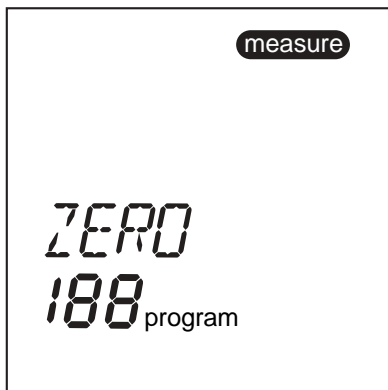

Zero with an Auto-Test™ Cuvette

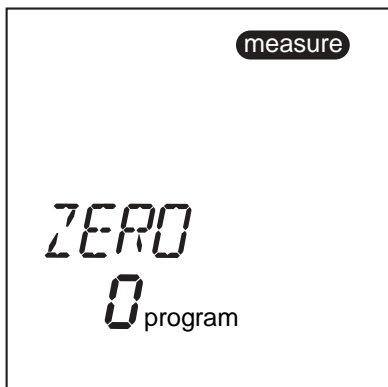

1. Press the  key to turn the AQ4000 colorimeter on. Ensure the correct adapter is in place.
2. Insert an Auto-Test zero cuvette into the sample well of the AQ4000.
3. Insert cuvette into AQ4000. Align the ▼ on the Auto-Test cuvette with the ◆ on the adapter to obtain a continuous beeping and view ***** across the display. If ***** and beeping is not observed, rotate cuvette right or left to initiate the measurement.
4. "COVER VIAL" will be displayed. Immediately cover the cuvette with the cuvette cover.
5. "WAIT" and "ZERO" will be displayed. Allow the AQ4000 to take the zero reading.
6. When complete, "0.000", "ZERO" and "0 program" will be displayed.
7. Remove cover and zero Auto-Test cuvette.

Zero Using a Standard Cuvette





1. Press the  key to turn the AQ4000 Colorimeter on.
2. Press  key to select program to run.
3. "ENT PRGM?" will be displayed. Enter the desired program number.
4. Fill a clean dry cuvette with zero solution.
5. Insert zero cuvette into colorimeter and cover with cuvette cover.
6. Press the  key.
7. "WAIT" and "ZERO" will be displayed. Allow the AQ4000 to take the zero reading.
8. When complete, "ZERO" and "0 program" will be displayed.
9. Remove cover and zero cuvette.

Sample Measurement with an Auto-Test™ Sample Cuvette

1. Place required amount of sample in the graduated sample cup provided. Sample cup is marked in 5 mL increments.
2. Add any required reagents as described in the test instructions.
3. Place Auto-Test cuvette in sample cup and snap tip by pressing cuvette stem against the side of the cup. Allow the Auto-Test cuvette to fill.
4. Small air bubbles in cuvette facilitate mixing. Invert Auto-Test cuvette several times to mix. Wipe any liquid from the outside of the cuvette before measurement.
5. Insert cuvette into AQ4000. Align the ▼ on the Auto-Test cuvette with the ◆ on the adapter to obtain a continuous beeping and view ***** across the display. If ***** and beeping is not observed, rotate cuvette right or left to initiate the measurement.
6. Immediately cover the cuvette with the cuvette cover.
7. If a wait time is required, the AQ4000 will begin to countdown. The AQ4000 will automatically proceed to the measure mode when wait time is complete.
8. The AQ4000 will display result. Record value or logdate. Proceed with next sample.
9. To initiate the next sample, repeat steps 1 – 8.

NOTE: To bypass timer, press  key to stop timer and initiate measurement.

Sample Measurement Using Standard non Auto-Test™ Reagent Cuvettes

1. Follow the instructions provided with the prepared colorimetric test kit sample.
2. Select program by pressing  key and enter the appropriate program number. See **Appendix B**.
3. Choose the appropriate size adapter for your cuvette. Insert adapter into the sample well insuring the slots and male tabs are aligned while pushing into position.
4. Cap cuvette and insert sample in the AQ4000 sample well. Cover with sample cover.
5. Press  key to initiate measurement.
6. If test has a wait period for sample color development, the countdown will begin.* The AQ4000 will automatically proceed to measure mode when wait time is complete.
7. The AQ4000 will display the result. Record value or log data. Proceed with next sample.

* **NOTE:** *If you have already waited the appropriate time, you can abort the timer and go directly to the measure mode by pressing the Timer Key.*

Chapter VI





Log Function

The AQ4000 colorimeter allows the user to store up to 100 points in the log.



To Log Data:

Once measurement is complete, press  key to log point prior to next measurement.

To Display Log:

1. Press and hold  key for approximately 3 sec.
2. "DISPLAY" will be displayed and last point in log will be displayed.
3. Use  or  keys to scroll through log points.
4. Press  key to escape log display mode

To Clear Log:

1. Go into log display mode, see above.
2. Press  key "CLR LOG?" will be displayed.
3. Press  key to clear log. "DELETE" will be displayed and AQ4000 will return to measure mode.
4. Press  key to abort log clear.

NOTE: It is recommended to print or download log prior to clearing.

To Print or Download Log:

1. Plug serial cable AQ4CBL into AQ4000.
2. Connect AQ4CBL cable to printer or computer. See Chapter III, **Print Setup**.
3. Go to log display mode and press  key.

Chapter VII

Use with Printers and Computers

The Model AQ4000 allows communication to a printer or bi-directional communication with a computer for the download of new methods. When connecting to a printer or a computer, use Thermo Orion Cat. No. AQ4CBL. This cable has a special 3-pin connector on one end for the AQ4000. When used to connect to a computer, a serial adapter may be required (a 25 pin to 9 pin adapter is included with AQ4CBL).







Data Transmission Settings

Baud Rate (selectable)	1200 (default), 2400, 4800, 9600
Parity	None
Data bits	8
Start bit	1
Stop bit	1

Chapter VIII

Troubleshooting

Colorimeter Self-test

1. To initiate self-test, press  key.
2. Press  or  key until display reads "SELFTEST".
3. Press  key to initiate self-test.
4. When "Press 7" is displayed, press the  key and follow the directions through the test.
5. When complete, unit should display "UNIT OK".
6. Press any key to confirm display operation.
7. Press any key to exit the self-test.
8. Press  key to return to measurement mode or press  key proceed through setup menu.

Maintenance

Colorimeter

- Wipe the outside of the colorimeter with a damp cloth.
- Use a lens tissue or a soft cloth to wipe off the sample compartment.

Cuvettes

- Always wipe moisture off any cuvette before inserting into the AQ4000.
- Always wipe fingerprints off any cuvette before inserting into the AQ4000.

Operator Assistance Codes

Operator Assistance Codes are used to inform a user of a problem during operation. See **Table 1** for these codes. Contact Thermo Orion's Technical Service Department at 1-800-225-1480 for assistance.

Table 1:

Error Code	Error Code Type
E11	Internal Hardware Error
E12	Internal Hardware Error
E13	Internal Hardware Error
E14	Internal Hardware Error
E19	Internal Hardware Error
E19	LCD Driver Error
OVERRNG	Measurement exceeds upper operational range
UNDRNG	Measurement exceeds lower operational range

Chapter IX

Warranty

The Thermo Orion warranty covers failures due to manufacturer's workmanship or material defects from the date of purchase by the user. User should return the warranty card to Thermo Orion and retain proof of purchase. Warranty is void if product has been abused, misused, or repairs attempted by unauthorized persons.

Warranties herein are for product sold/installed by Thermo Orion or its authorized dealers.

Any product sold by a U.S. or Canadian distributor must be returned to Thermo Orion for any warranty work. Field service is available on Liquid Handling Devices, BOD AutoEZ™, EZFlash® GC Accessory, TEA Analyzer® and Incubators. Please contact our Technical Service department for further information. A Return Authorization Number must be obtained from Thermo Orion Laboratory Technical Service before returning any product for in-warranty repair or replacement.

In the event of failure within the warranty period, Thermo Orion will at Thermo Orion's option, repair or replace product not conforming to this warranty. There may be additional charges, including freight, for warranty service performed in some countries. For service, call Thermo Orion (or its authorized dealer outside the United States and Canada). Thermo Orion reserves the right to ask for proof of purchase, such as the original invoice or packing slip.

Laboratory pH Meters (Models 301, 611 and 940), SensorLink®, pHuture® pH Meters (Models 610 and 620), Smart Chek™ Meters, Sage® Pumps, Cahn® Balances, 930 Ionalyzer®, 950 ROSS™ FAST QC™ Titrator, 960 Titrator PLUS®, Karl Fischer Titrators, Autosamplers, Liquid Handling Devices, Liquid Handling Automation Workstations (Models AS2000, AS2500, AS4000), Pumps (Models SP201, SP201-HR, SP201-S, Peristaltic and Rinse), pHuture Conversion Box, Wine Master®, 607 Switchbox, rf link™, AQUAfast® II Colorimeters, COD125 Reactor, Vacuum Degassers and Flowmeter are warranted to be free from defects in material and workmanship for a period of twelve (12) months from the date of purchase by the user or eighteen (18) months from date of factory shipment, whichever is earlier, provided use is in accordance with the operating limitations and maintenance procedures in the instruction manual and when not having been subjected to accident, alteration, misuse, or abuse.

The warranty period for 960 Titrator PLUS, 950 Fast QC Titrator, Wine Master and 930 Ionalyzer pumps is three (3) months from date of purchase.

Economy Line Electrodes, Models 91-05, 91-06, 91-15, 91-16, 91-25, 91-26, 91-35, 91-36, 92-06 are warranted to be free from defects in material and workmanship for a period of three (3) months from date of purchase by customer or six (6) months from date of shipment from Thermo Orion, whichever is earlier. Warranty also includes failure for any reason (excluding breakage), except abuse, provided the electrode is not used in solutions containing silver, sulfide, perchlorate, or hydrofluoric acid; or in solutions more than one (1) Molar in strong acid or base at temperatures above 50 °C.

Ion Selective Electrodes, ionplus® Electrodes, ROSS™ Electrodes, Sure-Flow® Electrodes, No Cal™ pH Electrodes, PerpHecT® Electrodes, AquaPro Professional Electrodes, Standard Line pH Electrodes, Tris pH Electrodes, ORP Triode™ (Cat. No. 9180BN), pHuture® pH Probes (Cat. No. 616500) and pHuture MMS™ Quatrode™ and Triode (Cat. Nos. 616600 and 617900), Model 97-08 DO Probe, Series 100 Conventional Conductivity Cells, temperature probes and compensators (except those models noted) are warranted to be free from defects in material and workmanship for a period of twelve (12) months from the date of purchase by the customer or eighteen (18) months from date of shipment from Thermo Orion, whichever is earlier, except for abuse or breakage of electrodes. 93 and 97 ionplus Series sensing modules are warranted to give six (6) months of operation if placed in service before the date indicated on the package, except 93-07 and 97-07 Nitrate modules are warranted to give ninety (90) days of operation if placed in service before the date indicated on the package.

Thermo Orion pHuture Electrode (Cat. No. 615700) and pHuture MMS Pentrode™ (Cat. No. 617500), Quatrode (Cat. No. 617800) and Triode (Cat. No. 615800), Low Maintenance Triode (Cat. No. 9107BN), ORP Low Maintenance Triode (Cat. No. 9179BN), and PerpHecT Low Maintenance Triode (Cat. No. 9207BN), Waterproof Triode (Cat. Nos. 9107WP, 9107WL, 9109WL and 9109WP), QuiKcheK™ Meters and Micro Electrodes are warranted to be free from defects in material and workmanship for a period of six (6) months from date of purchase by the customer or twelve (12) months from date of shipment from Thermo Orion, whichever is earlier, when used in accordance with the operating limitations and maintenance procedure in the instruction manual and when not having been subjected to accident, alteration, misuse or abuse.

AQUAfast® IV Colorimeters, ROSS Ultra™, Series 100 DuraProbe™ Conductivity Cells and Series 800 Dissolved Oxygen Probes are warranted to be free from defects in material and workmanship for a period of twenty-four (24) months from the date of purchase by the user or thirty (30) months from the date of shipment from Thermo Orion, whichever is earlier, provided use is in accordance with the operating limitations and maintenance procedures in the instruction manual and when not having been subjected to accident, alteration, misuse, or abuse.

Waterproof Meters (Models 630, 635, 830A, 835A, 260A, 261S, 265A, 266S, 130A, 131S, 135A, 136S, 1230, 142 and 842), Conductivity Meters (Models 105Aplus™, 115Aplus, 125Aplus, 145Aplus, 150Aplus and 162A), PerpHecT pH/ISE Meters, pH/ISE Meters (Models 210Aplus, 230Aplus, 250Aplus, 290Aplus, 410Aplus, 420Aplus, 520Aplus, 525Aplus, 710Aplus, 720Aplus and 920Aplus), pHuture MMS Meters (Models 535A and 555A), pH/Conductivity Meter (Model 550A), Dissolved Oxygen Meters (Models 810Aplus, 850Aplus and 862A) are warranted to be free from defects in material and workmanship for a period of thirty-six (36) months from the date of purchase by the user or forty-two (42) months from date of shipment from Thermo Orion, whichever is earlier, provided use is in accordance with the operating limitations and maintenance procedures in the instruction manual and when not having been subjected to accident, alteration, misuse or abuse.

DataCOLLECT™ and Vista™ Software carry an “out-of-box” warranty. Should it fail to work when first used, contact Thermo Orion immediately for replacement.

Thermo Orion Meter, Electrode and Analytical System Accessories (such as Cables, Cases, Line adapters, Standards, Printers, etc.), Solutions, AQUAfast® Test Strips, AQUAfast II Reagents, Kits and Accessories, AQUAfast IV Reagents, Kits and Accessories, Series 800 Dissolved Oxygen Probe Membranes, Cahn® Balance Accessories (such as Cables, Line Adapters, Printers, etc), Liquid Handling Automation Cases, Kits and System Accessories (such as Cables, Probes, Tubing, Ferrules, etc.) and EZFlash® columns and accessories carry an “out-of-box” warranty. Should they fail to work when first used, contact Thermo Orion immediately for replacement. Should Thermo Orion Solutions or Buffers be unusable when first “out-of-box,” contact Thermo Orion immediately for replacement.

Thermo Orion EZFlash GC Accessory and TEA Analyzer® Models 610 and 510 carry a twelve (12) month warranty, excluding consumable items.

Incubators have a full one-year parts and labor warranty. The CO₂ gas sensor (T/C) is covered by a five-year warranty. The CO₂ gas sensor (IR) and CO₂ fuel sensor are covered by a two-year warranty. The construction and integrity of the water jacket chamber is covered by a lifetime warranty.

For products in the catalog not listed in this warranty statement, please visit our website at: www.thermoorion.com

THE WARRANTIES DESCRIBED ABOVE ARE EXCLUSIVE AND IN LIEU OF ALL OTHER WARRANTIES WHETHER STATUTORY, EXPRESS OR IMPLIED INCLUDING, BUT NOT LIMITED TO, ANY IMPLIED WARRANTY OF MERCHANTABILITY OR FITNESS FOR A PARTICULAR PURPOSE AND ALL WARRANTIES ARISING FROM THE COURSE OF DEALING OR USAGE OF TRADE. THE BUYER'S SOLE AND EXCLUSIVE REMEDY IS FOR REPAIR OR REPLACEMENT OF THE NON-CONFORMING PRODUCT OR PART THEREOF, OR REFUND OF THE PURCHASE PRICE, BUT IN NO EVENT SHALL THERMO ORION (ITS CONTRACTORS AND SUPPLIERS OF ANY TIER) BE LIABLE TO THE BUYER OR ANY PERSON FOR ANY SPECIAL, INDIRECT, INCIDENTAL, OR CONSEQUENTIAL DAMAGES WHETHER THE CLAIMS ARE BASED IN CONTRACT, IN TORT (INCLUDING NEGLIGENCE), OR OTHERWISE WITH RESPECT TO OR ARISING OUT OF THE PRODUCT FURNISHED HEREUNDER.

REPRESENTATION AND WARRANTIES MADE BY ANY PERSON, INCLUDING ITS AUTHORIZED DEALERS, REPRESENTATIVES AND EMPLOYEES OF THERMO ORION WHICH ALTER OR ARE IN ADDITION TO THE TERMS OF THIS WARRANTY SHALL NOT BE BINDING UPON THERMO ORION UNLESS IN WRITING AND SIGNED BY ONE OF ITS OFFICERS.

Note: For in- or out-of-warranty repair or service, contact Thermo Orion Technical Service (or its authorized dealer outside the United States and Canada). Technical Service will issue a Return Authorization (RA) for all repair services. You must have a Thermo Orion RA prior to returning/forwarding any product to Thermo Orion.

Chapter X

Declaration of Conformity

Manufacturer:

Thermo Orion
500 Cummings Center
Beverly, MA 01915 U.S.A

hereby declares that the Colorimeter Model AQ4000 product conform with the following standards and documents

Safety	EC Directive 72/23/EEC Low Voltage Directive
EMC	EC 89/336/EEC Electromagnetic Compatibility EN/IEC 61326:1997 + A1: 1998, Annex C
Emissions:	EN 55011 (Class A) Emissions FCC Part 15 Class A Canadian Emissions (EMCAB-3 ISSUE 2)
Immunity:	DIN EN 50082-2 Feb.1996 Generic Immunity IEC 61000-4-2 March 1996 ESD Susceptibility IEC 61000-4-3 1995 Radiated Immunity

This device complies with part 15 of the FCC Rules. Operation is subject to the following two conditions: (1) This device may not cause harmful interference, and (2) this device must accept any interference received, including interference that may cause undesired operation.

This Class A digital apparatus meets all requirements of the Canadian Interference-Causing Equipment Regulations.

These products have been manufactured in compliance with the provisions of the relevant Thermo Orion manufacturing and test documents and processes. Further, these documents and processes are recognized as complying with ISO 9001: 1994(E) by QMI, listed as File #001911.

Place and date of issue:
Beverly, MA. USA
April 25, 2001

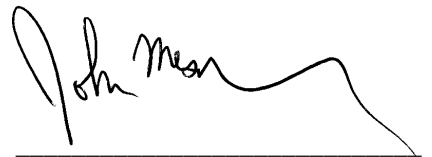

John Meserve
Quality Assurance Manager

Chapter XI

Specifications

	AQ4000
Wavelength (nm)	420, 520, 580, 610
Wavelength Accuracy	± 2 nm
Wavelength Selection	Automatic
Photometric Linearity	± 0.002 A (0-1 A)
Photometric Reproducibility	± 0.005 A (0-1 A)
Photometric Accuracy	± 0.005A @ 1.0 ABS Nominal
Photometric Range	0 – 2 A
Stray Light	< 1.0% at 400 nm
Source Lamp	Light Emitting Diode (LED)
Detector	Photodiode
Bandwidth	10 ± 2 nm

Environmental Conditions

Temperature Operating Range	0.0 to 45.0 °C
Humidity	90% at 50.0 °C max
Waterproof	IP67

Inputs

Keypad	12 dual – function keys with tactile feedback
RS232	Yes
Sample Chamber	24 mm, 16 mm, & 13 mm
Auto-Test™ Recognition	13 mm cuvette only

AQ4000

Display	Custom LCD
Units	mg/L, ppm, µg/L, Absorbancy, or % Transmittance
Low Battery Indicator	Yes
RS232	Yes

Software Features

Programmed Methods	190 & 10 user defined
Datalogging	100 points
Built-in Timer	Yes
Zero and Blank	Yes
Standby Mode	Yes
Capability for Downloading of New Methods	Yes

Electrical Features

Power	4 AA Batteries
Battery Life	2,500 hours (Alkaline) 10,000 hours (Lithium)
Non-volatile Memory	Yes

Appendix A.

Ordering Information

Cat. No.	Description
AQ4000	AQIV Advanced Colorimeter
AQ4CBL	AQIV Cable RS232
AQ40FK	AQIV Field Kit only
AQ4ZER	AQIV Auto-ID® Zero Cuvette, Pk of 3
AC4011	AQIV Ammonia HR Auto-Test™, 30 Tests
AC4012	AQIV Ammonia LR Auto-Test, 30 Tests
AC4010	AQIV Ammonia ULR Auto-Test, 30 Tests
AC4027	AQIV Aluminum Auto-Test, 30 Tests
AC4035	AQIV Bromine Auto-Test, 30 Tests
AC4070	AQIV Chlorine (free and total) Auto-Test, 30 Tests
AC4017	AQIV Chloride Auto-Test, 30 Tests
AC4099	AQIV Chlorine Dioxide Auto-Test, 30 Tests
AC4029	AQIV Copper (soluble) Auto-Test, 30 Tests
AC4006	AQIV Cyanide (free) Auto-Test, 30 Tests
AC4009	AQIV Fluoride Auto-Test, 30 Tests
AC4030	AQIV Hydrazine Auto-Test, 30 Tests
AC4078	AQIV Iron 1 (total & soluble) Auto-Test, 30 Tests
AC4055	AQIV Manganese Auto-Test, 30 Tests
AC4042	AQIV Molybdate Auto-Test, 30 Tests
AC4004	AQIV Nitrate (as N) -LR Auto-Test, 30 Tests
AC4005	AQIV Nitrate 2 (as N) -MR Auto-Test, 30 Tests
AC4007	AQIV Nitrate 3 (as NO ₃) -HR Auto-Test, 30 Tests
AC4046	AQIV Nitrite Auto-Test, 30 Tests
AC4008	AQIV Oxygen Auto-Test, 30 Tests
AC4048	AQIV Ozone Auto-Test, 30 Tests
AC4095	AQIV Phosphate 2 -LR Auto-Test, 30 Tests
AC4096	AQIV Phosphate 1 -HR Auto-Test, 30 Tests

Cat. No.	Description
AC4060	AQIV Silica Auto-Test™, 30 Tests
AC4082	AQIV Sulfate Auto-Test, 30 Tests
AC4016	AQIV Sulfide (soluble) Auto-Test, 30 Tests
AC4065	AQIV Zinc Auto-Test, 30 Tests
AC2002	AQII Alkalinity-m, 100 Tests
AC2027	AQII Aluminum, 50 Tests
AC2017	AQII Chloride, 50 Tests
AC2070	AQII Chlorine Free & Total, 50 Tests
AC2071	AQII Chlorine Free, 100 Tests
AC2072	AQII Chlorine Total, 100 Tests
AC2029	AQII Copper (Biquinoline), 50 Tests
AC2065	AQII Copper/Zinc, 50 Tests
AC2009	AQII Fluoride, 50 Tests
AC2030	AQII Hydrazine, 30 Tests
AC2078	AQII Iron (2 ranges), 100 Tests
AC2055	AQII Manganese, 50 Tests
AC2007	AQII Nitrate, 50 Tests
AC2046	AQII Nitrite, 100 Tests
AC2012	AQII Ammonia as Nitrogen (2 ranges), 50 Tests
AC2001	AQII pH, 100 Tests
AC2095	AQII Phosphate LR, 50 Tests
AC2096	AQII Phosphate HR, 50 Tests
AC2060	AQII Silica, 50 Tests
AC2061	AQII Silica Phosphate Removal, 100 Tests
AC2082	AQII Sulfate, 100 Tests
AC2016	AQII Sulfide, 50 Tests
AC2CUV	24 mm Cuvettes, pk of 4

Cat. No.	Description
COD125	Thermo Reactor
CODL00	AQIV COD, 0-150 ppm, 25 Tests
CODH00	AQIV COD, 0-1,500 ppm, 25 Tests
CODHP0	AQIV COD, 0-15,000 ppm, 25 Tests
CODS01	COD Standard, 1,000 ppm, 475 mL
CODS10	COD standard, 10,000 ppm, 475 mL
AC2C16	16 mm Cuvettes, pk of 5
AC4P71	AQIV Chlorine Free Powder Chemistry Packs, 100 Tests
AC4P72	AQIV Chlorine Total Powder Chemistry Packs, 100 Tests
AC4P29	AQIV Copper (Bicinchoninate) Powder Chemistry Packs, 100 Tests
AC4P78	AQIV Iron, Ferro Powder Chemistry Packs, 100 Tests
AC4P79	AQIV Iron, TPTZ Powder Chemistry Packs, 100 Tests
AC4P55	AQIV Manganese HR Powder Chemistry Packs, 100 Tests
AC4P42	AQIV Molybdenum, Molybdate HR Powder Chemistry Packs, 100 Tests
AC4P46	AQIV Nitrite LR Powder Chemistry Packs, 100 Tests
AC4P12	AQIV Ammonia, Nitrogen HR Powder Chemistry Packs, 100 Tests
AC4P95	AQIV Phosphorus LR Powder Chemistry Packs, 100 Tests
AC4P60	AQIV Silica HR Powder Chemistry Packs, 100 Tests
AC4P82	AQIV Sulfate 4 Powder Chemistry Packs, 100 Tests

Appendix B.

List of Program Numbers

Program ID	Cat. No.	Test
005	AC4035	Bromine
006	AC4099	Chlorine Dioxide
007	AC4029	Copper (soluble)
008	AC4006	Cyanide (free)
009	AC4030	Hydrazine
010	AC4078	Iron 1 (total & soluble)
011	AC4042	Molybdate
012	AC4004	Nitrate (as N) - LR
013	AC4005	Nitrate 2 (as N) - MR
014	AC4007	Nitrate 3 (as NO ₃) - HR
015	AC4008	Oxygen
016	AC4048	Ozone
017	AC4095	Phosphate 2 - LR
018	AC4096	Phosphate 1 - HR
019	AC4060	Silica
020	AC4016	Sulfide (soluble)
021	AC4065	Zinc
022	AC4070	Chlorine (free and total)
023	AC4012	Ammonia (low range)
024	AC4011	Ammonia (high range)
025	AC4046	Nitrite
026	AC4009	Fluoride
027	AC4082	Sulfate
028	AC4055	Manganese

Program ID	Cat. No.	Test
031	AC4017	Chloride
033	AC4027	Aluminum
034	AC4010	Ammonia ULR
041	CODL00	COD 0 - 150 ppm
042	CODH00	COD 0 - 1,500 ppm
043	CODHP0	COD 0 - 15,000 ppm
050	AC4P71	Chlorine Free, Powder Chemistry
051	AC4P72	Chlorine Total, Powder Chemistry
052	AC4P29	Copper Bicinchonate, Powder Chemistry
053	AC4P78	Iron, Ferro, Powder Chemistry
054	AC4P79	Iron, TPTZ, Powder Chemistry
055	AC4P55	Manganese HR, Powder Chemistry
056	AC4P42	Molybdenum, Molybdate HR, Powder Chemistry
057	AC4P46	Nitrite LR, Powder Chemistry
058	AC4P12	Ammonia, Nitrogen, Powder Chemistry
059	AC4P95	Phosphorus LR, Powder Chemistry
060	AC4P60	Silica HR, Powder Chemistry
061	AC4P82	Sulfate 4, Powder Chemistry
128	AC2007	Nitrate, Tablet Chemistry
129	AC2078	Iron LR, Tablet Chemistry
130	AC2078	Iron HR, Tablet Chemistry
131	AC2012	Ammonia as Nitrogen LR, Tablet Chemistry
132	AC2012	Ammonia as Nitrogen HR, Tablet Chemistry

Program ID	Cat. No.	Test
133	AC2070, AC2071, AC2072	Chlorine Free & Total, Tablet Chemistry
134	AC2009	Fluoride
135	AC2002	Alkalinity, Tablet Chemistry
136	AC2027	Aluminum, Tablet Chemistry
137	AC2029	Copper, Biquinoline, Tablet Chemistry
138	AC2065	Copper LR, Tablet Chemistry
139	AC2055	Manganese, Tablet Chemistry
140	AC2046	Nitrite, Tablet Chemistry
141	AC2096	Phosphorus HR, Tablet Chemistry
142	AC2095	Phosphorus LR, Tablet Chemistry
143	AC2016	Sulfide, Tablet Chemistry
144	AC2082	Sulfate, Tablet Chemistry
145	AC2065	Zinc, Tablet Chemistry
147	AC2017	Chloride, Tablet Chemistry
149	AC2030	Hydrazine, Tablet Chemistry
151	AC2001	pH, Tablet Chemistry
152	AC2060	Silica, Tablet Chemistry

Appendix C.

Method Sheets

The method sheets for the AQUAfast® IV Auto-Test™ reagents, COD chemistries, powder chemistries and tablet chemistries can be found on the Thermo Orion website at www.thermoorion.com.

North America

500 Cummings Center
Beverly, MA 01915-6199 USA
Tel: 978-232-6000
Dom. Fax: 978-232-6015
Int'l. Fax: 978-232-6031

Europe

12-16 Sedgeway Business Park
Witchford, Cambridgeshire
England, CB6 2HY
Tel: 44-1353-666111
Fax: 44-1353-666001

Far East

Room 904, Federal Building
369 Lockhart Road
Wanchai, Hong Kong
Tel: 852-2836-0981
Fax: 852-2834-5160

Customer Support

Toll Free: 800-225-1480
www.thermoorion.com
Dom. e-mail: domcs1@thermoorion.com
Int'l. e-mail: intcs1@thermoorion.com

Thermo Orion

A Thermo Electron business